

Battery Pack Test Report ***(Package Drop & UN38.3)***

Customer: Makita

Pack Model: BL1021B

Nominal voltage: 10.8V ~12V(max)

Nominal capacity: 22Wh/2.0Ah

Configuration: 3S1P

Celxpert P/N: 912900064/912900065

Cell Type: Sanyo RX 2000mAh

Aug.19 2014

Approved by _____) 竹野

Reviewed by _____)

Prepared by _____) 高野



Figure photo of the pack.



1. Package Drop Test Report

Test Period	2014/07/24		Test Spec.	IATA A55 & QS-3Q-043	
Sample Level	Mass Production	Sample Mode	Finished Product	Quantity	2 PCS

1.1 DESCRIPTION OF TEST EQUIPMENTS

Kingdom Technology KD-128AS drop tester. Description of performance:

Payload capacity: 160 lbs. (72.6 kg)

Payload dimensions: Length: 61 cm / Width: 76 cm / Height: 90cm

Drop height range: 30 - 180 cm

Base Plate Material: Solid Steel (Std.)

Base Plate Size: 76.2x114.3x1.3cm

1.2 TEST CONDITION

Drop height: 120cm

Drop weight: 0.567Kg

Drop position: One corner, three edges and three faces with 1 time. (Total: 7 drops).

Drop Position and sequence: Ref. attachment 1

1.3 SUMMARY OF TEST

Concluding the follow check items, the result of the test is **pass**.

Check items	Before	After
Battery pack function	<input checked="" type="checkbox"/> Normal <input type="checkbox"/> Fail	<input checked="" type="checkbox"/> Normal <input type="checkbox"/> Fail
Battery pack appearance	<input checked="" type="checkbox"/> Normal <input type="checkbox"/> Fail	<input checked="" type="checkbox"/> Normal <input type="checkbox"/> Fail
Package internal status	<input checked="" type="checkbox"/> Normal <input type="checkbox"/> Fail	<input checked="" type="checkbox"/> Normal <input type="checkbox"/> Fail
Package outside status	<input checked="" type="checkbox"/> Normal <input type="checkbox"/> Fail	<input checked="" type="checkbox"/> Normal <input type="checkbox"/> Fail

Test photographs please refer to Attachment 2

Function Check details please refer to Attachment 3

Attachment 1:



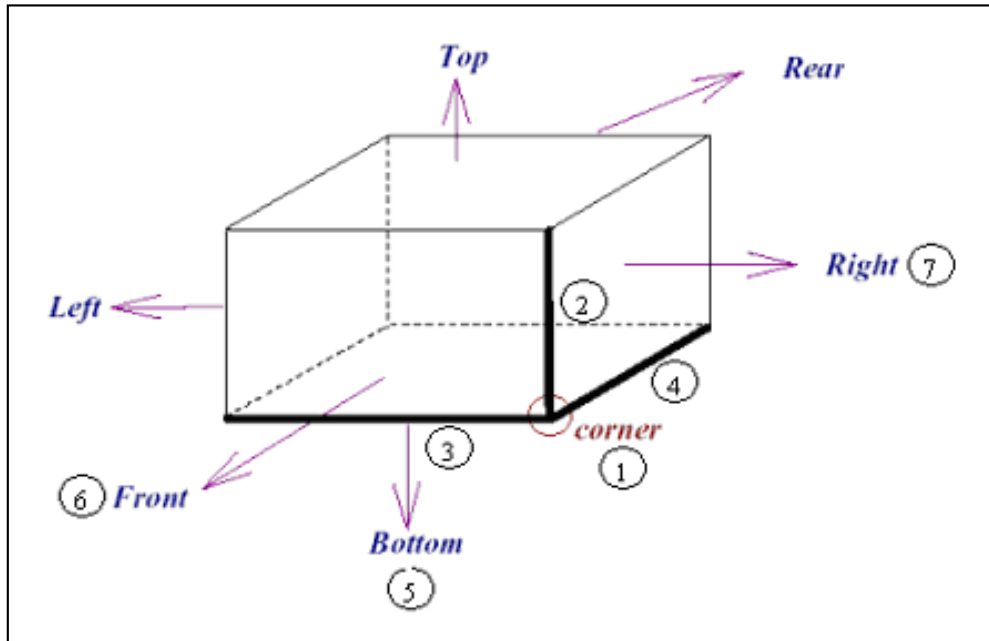





DROP POSITION



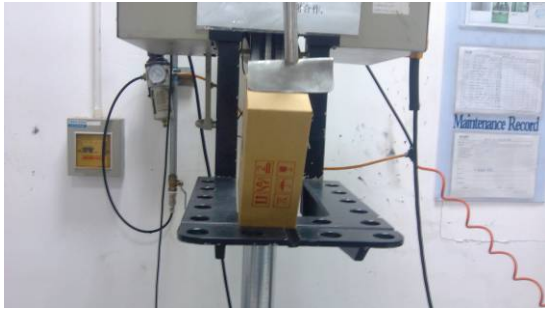



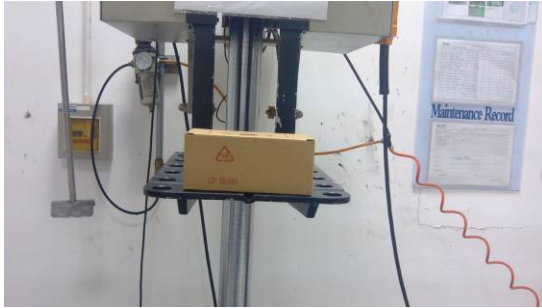

DROP SEQUENCE

<i>DROP</i>	<i>IMPACT SURFACE</i>
1	Corner (2-3-4)
2	Edge 1 (2)
3	Edge 2 (3)
4	Edge 3 (4)
5	Bottom (Flat 5)
6	Front (Flat 6)
7	Right (Flat 7)

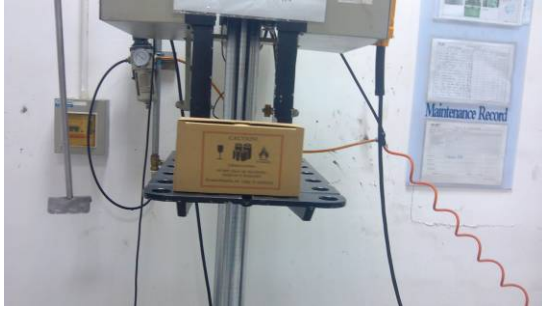
Attachment 2:

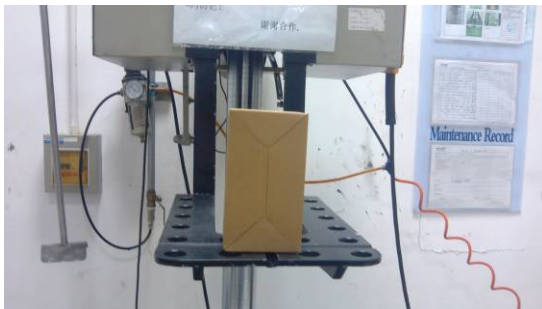
Drop Sequence	Test Setup	Test Result
1		
2		
3		
4		

Drop Sequence	Test Setup	Test Result
5		
6		
7		

Open Package check for internal after drop test



2. UN38.3 Test Report

Test Period	2014/7/30~2014/8/18		Test Spec.	ST/SG/AC.10/11/Rev.5 Amend.1	
Parts Name	Battery Pack	Application	NB	Quantity	Pack 16PCS/Cell 25pcs

2.1 Test Summary

Item	Test Item	Test Result	Details
T1	Altitude simulation test (UN38.3-1)	Pass	Page 9
T2	Thermal test (UN38.3-2)	Pass	Page 10
T3	Vibration test (UN38.3-3)	Pass	Page 11
T4	Shock test (UN38.3-4)	Pass	Page 12
T5	Short Circuit test (UN38.3-5)	Pass	Page 13
T6	Crush Test (UN38.3-6)	Pass	Page 13
T7	Overcharge test (UN38.3-7)	Pass	Page 14
T8	Forced discharge test (UN38.3-8)	Pass	Page 15

The battery pack passes UN38.3 test.

2.2 Test sample list

No.	Pack S/N	Test item	No.	Cell Num.	Test item
1	Sample No:1/16	38.3.1~5	1	Sanyo RX 2000mAh	38.3.6
2	Sample No:2/16	38.3.1~5	2	Sanyo RX 2000mAh	38.3.6
3	Sample No:3/16	38.3.1~5	3	Sanyo RX 2000mAh	38.3.6
4	Sample No:4/16	38.3.1~5	4	Sanyo RX 2000mAh	38.3.6
5	Sample No:5/16	38.3.1~5	5	Sanyo RX 2000mAh	38.3.6
6	Sample No:6/16	38.3.1~5	6	Sanyo RX 2000mAh	38.3.8
7	Sample No:7/16	38.3.1~5	7	Sanyo RX 2000mAh	38.3.8
8	Sample No:8/16	38.3.1~5	8	Sanyo RX 2000mAh	38.3.8
9	Sample No:9/16	38.3.7	9	Sanyo RX 2000mAh	38.3.8
10	Sample No:10/16	38.3.7	10	Sanyo RX 2000mAh	38.3.8
11	Sample No:11/16	38.3.7	11	Sanyo RX 2000mAh	38.3.8
12	Sample No:12/16	38.3.7	12	Sanyo RX 2000mAh	38.3.8
13	Sample No:13/16	38.3.7	13	Sanyo RX 2000mAh	38.3.8
14	Sample No:14/16	38.3.7	14	Sanyo RX 2000mAh	38.3.8
15	Sample No:15/16	38.3.7	15	Sanyo RX 2000mAh	38.3.8
16	Sample No:16/16	38.3.7	16	Sanyo RX 2000mAh	38.3.8
			17	Sanyo RX 2000mAh	38.3.8
			18	Sanyo RX 2000mAh	38.3.8
			19	Sanyo RX 2000mAh	38.3.8
			20	Sanyo RX 2000mAh	38.3.8
			21	Sanyo RX 2000mAh	38.3.8
			22	Sanyo RX 2000mAh	38.3.8
			23	Sanyo RX 2000mAh	38.3.8
			24	Sanyo RX 2000mAh	38.3.8
			25	Sanyo RX 2000mAh	38.3.8

2.3 Test result

Item	Test Item	Test specification	Judge criteria	Sample(s)																																																																																																																							
T1	Altitude Simulation (UN38.3-1)	1-1.4 batteries are standard charged. 4 batteries are 1C cycled 50 times, ending in fully charged state. All batteries weight is measured. The charged batteries voltage are measured and recorded. 1-2. Batteries shall be stored at a pressure of 11.6Kpa or less for at least six hours at ambient temperature 20+/-5 °C. 1-3. Vacuum is released. All cells weight is measured. The charged cell voltage are measured and recorded.	No mass loss (<0.1%), no leakage, no venting, no disassembly, no rupture and no fire. Battery voltage drop < 10%. Battery resistance change < ±10%.	4 packs are standard charged (Pack#1~4) 4 packs 50 cycled ending in fully charged states (Pack#5~8)																																																																																																																							
Test Period	Start: 2014/07/30 End:2014/07/30																																																																																																																										
Test Equipment	數位電表 Q153, 電子天平 Q090, 真空烘箱 Q146																																																																																																																										
Major Problem	-																																																																																																																										
Warning Point	-																																																																																																																										
Recommendation	The battery packs pass the test.																																																																																																																										
Raw Data	<table border="1"> <thead> <tr> <th colspan="11">Altitude Simulation Test on Charged Packs</th> </tr> <tr> <th rowspan="2">No.</th> <th colspan="3">Before</th> <th colspan="3">After</th> <th colspan="3">Difference</th> <th rowspan="2">Result</th> </tr> <tr> <th>OCV (V)</th> <th>Resistance(mΩ)</th> <th>Weight (g)</th> <th>OCV (V)</th> <th>Resistance(mΩ)</th> <th>Weight (g)</th> <th>Volt (%)</th> <th>Resistance(%)</th> <th>Weight (%)</th> </tr> </thead> <tbody> <tr> <td>1</td> <td>12.4369</td> <td>40.28</td> <td>248.69</td> <td>12.437</td> <td>40.58</td> <td>248.68</td> <td>0.00%</td> <td>0.74%</td> <td>0.00%</td> <td>Pass</td> </tr> <tr> <td>2</td> <td>12.4572</td> <td>39.63</td> <td>248.54</td> <td>12.456</td> <td>39.93</td> <td>248.53</td> <td>-0.01%</td> <td>0.76%</td> <td>0.00%</td> <td>Pass</td> </tr> <tr> <td>3</td> <td>12.4632</td> <td>41.57</td> <td>248.72</td> <td>12.465</td> <td>41.37</td> <td>248.71</td> <td>0.02%</td> <td>-0.48%</td> <td>0.00%</td> <td>Pass</td> </tr> <tr> <td>4</td> <td>12.4665</td> <td>42.31</td> <td>248.37</td> <td>12.460</td> <td>42.31</td> <td>248.36</td> <td>-0.05%</td> <td>1.13%</td> <td>0.00%</td> <td>Pass</td> </tr> <tr> <td>5</td> <td>12.4594</td> <td>40.87</td> <td>248.51</td> <td>12.457</td> <td>41.27</td> <td>248.50</td> <td>-0.02%</td> <td>0.98%</td> <td>0.00%</td> <td>Pass</td> </tr> <tr> <td>6</td> <td>12.4327</td> <td>41.34</td> <td>248.48</td> <td>12.430</td> <td>41.34</td> <td>248.47</td> <td>-0.02%</td> <td>1.21%</td> <td>0.00%</td> <td>Pass</td> </tr> <tr> <td>7</td> <td>12.4619</td> <td>38.72</td> <td>248.62</td> <td>12.461</td> <td>39.12</td> <td>248.61</td> <td>-0.01%</td> <td>1.03%</td> <td>0.00%</td> <td>Pass</td> </tr> <tr> <td>8</td> <td>12.4473</td> <td>39.15</td> <td>248.57</td> <td>12.447</td> <td>39.45</td> <td>248.56</td> <td>0.00%</td> <td>0.77%</td> <td>0.00%</td> <td>Pass</td> </tr> </tbody> </table>				Altitude Simulation Test on Charged Packs											No.	Before			After			Difference			Result	OCV (V)	Resistance(mΩ)	Weight (g)	OCV (V)	Resistance(mΩ)	Weight (g)	Volt (%)	Resistance(%)	Weight (%)	1	12.4369	40.28	248.69	12.437	40.58	248.68	0.00%	0.74%	0.00%	Pass	2	12.4572	39.63	248.54	12.456	39.93	248.53	-0.01%	0.76%	0.00%	Pass	3	12.4632	41.57	248.72	12.465	41.37	248.71	0.02%	-0.48%	0.00%	Pass	4	12.4665	42.31	248.37	12.460	42.31	248.36	-0.05%	1.13%	0.00%	Pass	5	12.4594	40.87	248.51	12.457	41.27	248.50	-0.02%	0.98%	0.00%	Pass	6	12.4327	41.34	248.48	12.430	41.34	248.47	-0.02%	1.21%	0.00%	Pass	7	12.4619	38.72	248.62	12.461	39.12	248.61	-0.01%	1.03%	0.00%	Pass	8	12.4473	39.15	248.57	12.447	39.45	248.56	0.00%	0.77%	0.00%	Pass
Altitude Simulation Test on Charged Packs																																																																																																																											
No.	Before			After			Difference			Result																																																																																																																	
	OCV (V)	Resistance(mΩ)	Weight (g)	OCV (V)	Resistance(mΩ)	Weight (g)	Volt (%)	Resistance(%)	Weight (%)																																																																																																																		
1	12.4369	40.28	248.69	12.437	40.58	248.68	0.00%	0.74%	0.00%	Pass																																																																																																																	
2	12.4572	39.63	248.54	12.456	39.93	248.53	-0.01%	0.76%	0.00%	Pass																																																																																																																	
3	12.4632	41.57	248.72	12.465	41.37	248.71	0.02%	-0.48%	0.00%	Pass																																																																																																																	
4	12.4665	42.31	248.37	12.460	42.31	248.36	-0.05%	1.13%	0.00%	Pass																																																																																																																	
5	12.4594	40.87	248.51	12.457	41.27	248.50	-0.02%	0.98%	0.00%	Pass																																																																																																																	
6	12.4327	41.34	248.48	12.430	41.34	248.47	-0.02%	1.21%	0.00%	Pass																																																																																																																	
7	12.4619	38.72	248.62	12.461	39.12	248.61	-0.01%	1.03%	0.00%	Pass																																																																																																																	
8	12.4473	39.15	248.57	12.447	39.45	248.56	0.00%	0.77%	0.00%	Pass																																																																																																																	

Item	Test Item	Test specification	Judge criteria	Sample(s)																																																																																																																							
T2	Thermal test (UN38.3-2)	2-1. Packs are stored for 6 hours at $72\pm 2^{\circ}\text{C}$, followed by storage for 6 hours at $-40\pm 2^{\circ}\text{C}$. The maximum time interval between test temperature extremes is 30 minutes. 2-2.Repeat 2-1 for 10 times. Then store the packs at ambient for 24 hours. All packs weight are measured. The charged battery voltage are measured and recorded.	No mass loss (<0.1%), no leakage, no venting, no disassembly, no rupture and no fire. Battery voltage drop < 10%. Battery resistance change < $\pm 10\%$.	4 packs are standard charged (Pack#1~4) 4 packs 50 cycled ending in fully charged states (Pack#5~8)																																																																																																																							
Test Period		Start: 2014/07/31 End:2014/08/06																																																																																																																									
Test Equipment		數位電表 Q153, 電子天平 Q090, 冷熱衝擊機 Q336																																																																																																																									
Major Problem		-																																																																																																																									
Warning Point		-																																																																																																																									
Recommendation		The packs pass the test.																																																																																																																									
Raw Data		<table border="1"> <thead> <tr> <th colspan="11">Thermal Test on Charged Packs</th> </tr> <tr> <th rowspan="2">No.</th> <th colspan="3">Before</th> <th colspan="3">After</th> <th colspan="3">Difference</th> <th rowspan="2">Result</th> </tr> <tr> <th>OCV (V)</th> <th>Resistance(mΩ)</th> <th>Weight (g)</th> <th>OCV (V)</th> <th>Resistance(mΩ)</th> <th>Weight (g)</th> <th>Volt (%)</th> <th>Resistance(%)</th> <th>Weight (%)</th> </tr> </thead> <tbody> <tr> <td>1</td> <td>12.4369</td> <td>40.58</td> <td>248.68</td> <td>12.368</td> <td>41.08</td> <td>248.58</td> <td>-4.80%</td> <td>1.23%</td> <td>0.04%</td> <td>Pass</td> </tr> <tr> <td>2</td> <td>12.4562</td> <td>39.93</td> <td>248.53</td> <td>12.380</td> <td>40.43</td> <td>248.42</td> <td>-0.61%</td> <td>1.25%</td> <td>0.04%</td> <td>Pass</td> </tr> <tr> <td>3</td> <td>12.4655</td> <td>41.37</td> <td>248.71</td> <td>12.390</td> <td>41.77</td> <td>248.60</td> <td>-0.60%</td> <td>0.97%</td> <td>0.04%</td> <td>Pass</td> </tr> <tr> <td>4</td> <td>12.4602</td> <td>42.81</td> <td>248.36</td> <td>12.386</td> <td>43.21</td> <td>248.26</td> <td>-0.59%</td> <td>0.93%</td> <td>0.04%</td> <td>Pass</td> </tr> <tr> <td>5</td> <td>12.4571</td> <td>41.27</td> <td>248.50</td> <td>12.386</td> <td>41.87</td> <td>248.40</td> <td>0.57%</td> <td>1.45%</td> <td>0.04%</td> <td>Pass</td> </tr> <tr> <td>6</td> <td>12.4797</td> <td>41.84</td> <td>248.47</td> <td>12.405</td> <td>42.24</td> <td>248.38</td> <td>-0.60%</td> <td>0.96%</td> <td>0.04%</td> <td>Pass</td> </tr> <tr> <td>7</td> <td>12.4609</td> <td>39.12</td> <td>248.61</td> <td>12.393</td> <td>39.72</td> <td>248.52</td> <td>-0.55%</td> <td>1.53%</td> <td>0.04%</td> <td>Pass</td> </tr> <tr> <td>8</td> <td>12.4473</td> <td>39.45</td> <td>248.56</td> <td>12.372</td> <td>39.95</td> <td>248.47</td> <td>-0.60%</td> <td>1.27%</td> <td>0.04%</td> <td>Pass</td> </tr> </tbody> </table>			Thermal Test on Charged Packs											No.	Before			After			Difference			Result	OCV (V)	Resistance(mΩ)	Weight (g)	OCV (V)	Resistance(mΩ)	Weight (g)	Volt (%)	Resistance(%)	Weight (%)	1	12.4369	40.58	248.68	12.368	41.08	248.58	-4.80%	1.23%	0.04%	Pass	2	12.4562	39.93	248.53	12.380	40.43	248.42	-0.61%	1.25%	0.04%	Pass	3	12.4655	41.37	248.71	12.390	41.77	248.60	-0.60%	0.97%	0.04%	Pass	4	12.4602	42.81	248.36	12.386	43.21	248.26	-0.59%	0.93%	0.04%	Pass	5	12.4571	41.27	248.50	12.386	41.87	248.40	0.57%	1.45%	0.04%	Pass	6	12.4797	41.84	248.47	12.405	42.24	248.38	-0.60%	0.96%	0.04%	Pass	7	12.4609	39.12	248.61	12.393	39.72	248.52	-0.55%	1.53%	0.04%	Pass	8	12.4473	39.45	248.56	12.372	39.95	248.47	-0.60%	1.27%	0.04%	Pass
Thermal Test on Charged Packs																																																																																																																											
No.	Before			After			Difference			Result																																																																																																																	
	OCV (V)	Resistance(mΩ)	Weight (g)	OCV (V)	Resistance(mΩ)	Weight (g)	Volt (%)	Resistance(%)	Weight (%)																																																																																																																		
1	12.4369	40.58	248.68	12.368	41.08	248.58	-4.80%	1.23%	0.04%	Pass																																																																																																																	
2	12.4562	39.93	248.53	12.380	40.43	248.42	-0.61%	1.25%	0.04%	Pass																																																																																																																	
3	12.4655	41.37	248.71	12.390	41.77	248.60	-0.60%	0.97%	0.04%	Pass																																																																																																																	
4	12.4602	42.81	248.36	12.386	43.21	248.26	-0.59%	0.93%	0.04%	Pass																																																																																																																	
5	12.4571	41.27	248.50	12.386	41.87	248.40	0.57%	1.45%	0.04%	Pass																																																																																																																	
6	12.4797	41.84	248.47	12.405	42.24	248.38	-0.60%	0.96%	0.04%	Pass																																																																																																																	
7	12.4609	39.12	248.61	12.393	39.72	248.52	-0.55%	1.53%	0.04%	Pass																																																																																																																	
8	12.4473	39.45	248.56	12.372	39.95	248.47	-0.60%	1.27%	0.04%	Pass																																																																																																																	

Item	Test Item	Test specification	Judge criteria	Sample(s)																																																																																																																							
T3	Vibration test (UN38.3-3)	3-1. Packs are firmly secured to the platform of the vibration machine without distorting the packs in such a manner as to faithfully transmit the vibration. The vibration shall be a sinusoidal waveform with a logarithmic sweep between 7 and 200 Hz and back to 7 Hz traversed in 15 minutes. This cycle shall be repeated 12 times for a total of 3 hours for each of 3 mutually perpendicular to the terminal face. 3-2. The logarithmic frequency sweep is as follows: 7-18 Hz → 1gn 18-50 Hz → 0.8mm amplitude 50-200 Hz → 8gn 3-3. All packs weight are measured. The charged packs voltage are measured and recorded.	No mass loss (<0.1%), no leakage, no venting, no disassembly, no rupture and no fire. Battery voltage drop < 10%. Battery resistance change < ±10%	4 packs are standard charged (Pack#1~4) 4 packs 50 cycled ending in fully charged states (Pack#5~8)																																																																																																																							
Test Period	Start: 2014/08/11 End:2014/08/11																																																																																																																										
Test Equipment	數位電表 Q153, 電子天平 Q090, 振動測試機 Q300																																																																																																																										
Major Problem	-																																																																																																																										
Warning Point	-																																																																																																																										
Recommendation	The packs pass the test.																																																																																																																										
Raw Data	<table border="1"> <thead> <tr> <th colspan="11">Vibration Test on Charged Packs</th> </tr> <tr> <th rowspan="2">No.</th> <th colspan="3">Before</th> <th colspan="3">After</th> <th colspan="3">Difference</th> <th rowspan="2">Result</th> </tr> <tr> <th>OCV (V)</th> <th>Resistance(mΩ)</th> <th>Weight (g)</th> <th>OCV (V)</th> <th>Resistance(mΩ)</th> <th>Weight (g)</th> <th>Volt (%)</th> <th>Resistance(%)</th> <th>Weight (%)</th> </tr> </thead> <tbody> <tr> <td>1</td> <td>12.3679</td> <td>41.08</td> <td>248.58</td> <td>12.361</td> <td>41.68</td> <td>248.55</td> <td>-0.51%</td> <td>1.46%</td> <td>0.01%</td> <td>Pass</td> </tr> <tr> <td>2</td> <td>12.3802</td> <td>40.43</td> <td>248.42</td> <td>12.373</td> <td>41.03</td> <td>248.40</td> <td>-0.06%</td> <td>1.48%</td> <td>0.01%</td> <td>Pass</td> </tr> <tr> <td>3</td> <td>12.3905</td> <td>41.77</td> <td>248.60</td> <td>12.382</td> <td>42.27</td> <td>248.58</td> <td>-0.06%</td> <td>1.20%</td> <td>0.01%</td> <td>Pass</td> </tr> <tr> <td>4</td> <td>12.3862</td> <td>43.21</td> <td>248.26</td> <td>12.378</td> <td>43.91</td> <td>248.24</td> <td>-0.06%</td> <td>1.62%</td> <td>0.01%</td> <td>Pass</td> </tr> <tr> <td>5</td> <td>12.3864</td> <td>41.87</td> <td>248.40</td> <td>12.378</td> <td>42.57</td> <td>248.38</td> <td>-0.06%</td> <td>1.67%</td> <td>0.01%</td> <td>Pass</td> </tr> <tr> <td>6</td> <td>12.4047</td> <td>42.24</td> <td>248.38</td> <td>12.399</td> <td>42.74</td> <td>248.35</td> <td>-0.05%</td> <td>1.18%</td> <td>0.01%</td> <td>Pass</td> </tr> <tr> <td>7</td> <td>12.3929</td> <td>39.72</td> <td>248.52</td> <td>12.384</td> <td>40.12</td> <td>248.49</td> <td>-0.07%</td> <td>1.01%</td> <td>0.01%</td> <td>Pass</td> </tr> <tr> <td>8</td> <td>12.3723</td> <td>39.95</td> <td>248.47</td> <td>12.365</td> <td>40.55</td> <td>248.44</td> <td>-0.06%</td> <td>1.50%</td> <td>0.01%</td> <td>Pass</td> </tr> </tbody> </table>				Vibration Test on Charged Packs											No.	Before			After			Difference			Result	OCV (V)	Resistance(mΩ)	Weight (g)	OCV (V)	Resistance(mΩ)	Weight (g)	Volt (%)	Resistance(%)	Weight (%)	1	12.3679	41.08	248.58	12.361	41.68	248.55	-0.51%	1.46%	0.01%	Pass	2	12.3802	40.43	248.42	12.373	41.03	248.40	-0.06%	1.48%	0.01%	Pass	3	12.3905	41.77	248.60	12.382	42.27	248.58	-0.06%	1.20%	0.01%	Pass	4	12.3862	43.21	248.26	12.378	43.91	248.24	-0.06%	1.62%	0.01%	Pass	5	12.3864	41.87	248.40	12.378	42.57	248.38	-0.06%	1.67%	0.01%	Pass	6	12.4047	42.24	248.38	12.399	42.74	248.35	-0.05%	1.18%	0.01%	Pass	7	12.3929	39.72	248.52	12.384	40.12	248.49	-0.07%	1.01%	0.01%	Pass	8	12.3723	39.95	248.47	12.365	40.55	248.44	-0.06%	1.50%	0.01%	Pass
Vibration Test on Charged Packs																																																																																																																											
No.	Before			After			Difference			Result																																																																																																																	
	OCV (V)	Resistance(mΩ)	Weight (g)	OCV (V)	Resistance(mΩ)	Weight (g)	Volt (%)	Resistance(%)	Weight (%)																																																																																																																		
1	12.3679	41.08	248.58	12.361	41.68	248.55	-0.51%	1.46%	0.01%	Pass																																																																																																																	
2	12.3802	40.43	248.42	12.373	41.03	248.40	-0.06%	1.48%	0.01%	Pass																																																																																																																	
3	12.3905	41.77	248.60	12.382	42.27	248.58	-0.06%	1.20%	0.01%	Pass																																																																																																																	
4	12.3862	43.21	248.26	12.378	43.91	248.24	-0.06%	1.62%	0.01%	Pass																																																																																																																	
5	12.3864	41.87	248.40	12.378	42.57	248.38	-0.06%	1.67%	0.01%	Pass																																																																																																																	
6	12.4047	42.24	248.38	12.399	42.74	248.35	-0.05%	1.18%	0.01%	Pass																																																																																																																	
7	12.3929	39.72	248.52	12.384	40.12	248.49	-0.07%	1.01%	0.01%	Pass																																																																																																																	
8	12.3723	39.95	248.47	12.365	40.55	248.44	-0.06%	1.50%	0.01%	Pass																																																																																																																	

Item	Test Item	Test specification	Judge criteria	Sample(s)																																																																																																																							
T4	Shock test (UN38.3-4)	4-1. Packs shall be secured to the testing machine by means of a rigid mount, which will support all mounting surfaces. 4-2. Packs shall be subjected to a half-sine shock of peak acceleration 150gn and pulse duration of 6 milliseconds. Each pack shall be subjected to 3 shocks in the positive direction followed by three shocks in the negative direction of three mutually perpendicularly mounting positions of the pack for a total of 18 shocks. 4-3. All batteries weight are measured. The charged cell voltage are measured and recorded.	No mass loss (<0.1%), no leakage, no venting, no disassembly, no rupture and no fire. Battery voltage drop < 10%. Battery resistance change < ±10%.	4 packs are standard charged (Pack#1~4) 4 packs 50 cycled ending in fully charged states (Pack#5~8)																																																																																																																							
Test Period	Start: 2014/08/12 End:2014/08/12																																																																																																																										
Test Equipment	數位電表 Q153, 電子天平 Q090, 衝擊測試機 Q154																																																																																																																										
Major Problem	-																																																																																																																										
Warning Point	-																																																																																																																										
Recommendation	The packs pass the test.																																																																																																																										
Raw Data	<table border="1"> <thead> <tr> <th colspan="11">Shock Test on Charged Packs</th> </tr> <tr> <th rowspan="2">No.</th> <th colspan="3">Before</th> <th colspan="3">After</th> <th colspan="3">Difference</th> <th rowspan="2">Result</th> </tr> <tr> <th>OCV (V)</th> <th>Resistance(mΩ)</th> <th>Weight (g)</th> <th>OCV (V)</th> <th>Resistance(mΩ)</th> <th>Weight (g)</th> <th>Volt (%)</th> <th>Resistance(%)</th> <th>Weight (%)</th> </tr> </thead> <tbody> <tr> <td>1</td> <td>1.3609</td> <td>41.68</td> <td>248.55</td> <td>1.355</td> <td>42.18</td> <td>248.54</td> <td>-0.44%</td> <td>1.20%</td> <td>0.00%</td> <td>Pass</td> </tr> <tr> <td>2</td> <td>12.3732</td> <td>41.03</td> <td>248.40</td> <td>12.368</td> <td>41.53</td> <td>248.39</td> <td>-0.04%</td> <td>1.22%</td> <td>0.00%</td> <td>Pass</td> </tr> <tr> <td>3</td> <td>12.3825</td> <td>42.27</td> <td>248.58</td> <td>12.377</td> <td>42.67</td> <td>248.57</td> <td>-0.04%</td> <td>0.95%</td> <td>0.00%</td> <td>Pass</td> </tr> <tr> <td>4</td> <td>12.3782</td> <td>43.91</td> <td>248.24</td> <td>12.372</td> <td>44.21</td> <td>248.23</td> <td>-0.05%</td> <td>0.68%</td> <td>0.00%</td> <td>Pass</td> </tr> <tr> <td>5</td> <td>12.3784</td> <td>42.57</td> <td>248.38</td> <td>12.374</td> <td>43.07</td> <td>248.37</td> <td>-0.03%</td> <td>1.17%</td> <td>0.00%</td> <td>Pass</td> </tr> <tr> <td>6</td> <td>12.3987</td> <td>42.74</td> <td>248.35</td> <td>12.392</td> <td>43.14</td> <td>248.35</td> <td>-0.06%</td> <td>0.94%</td> <td>0.00%</td> <td>Pass</td> </tr> <tr> <td>7</td> <td>12.3839</td> <td>40.12</td> <td>248.49</td> <td>12.378</td> <td>40.72</td> <td>248.48</td> <td>-0.05%</td> <td>1.50%</td> <td>0.00%</td> <td>Pass</td> </tr> <tr> <td>8</td> <td>12.3653</td> <td>40.55</td> <td>248.44</td> <td>12.360</td> <td>41.05</td> <td>248.44</td> <td>-0.04%</td> <td>1.23%</td> <td>0.00%</td> <td>Pass</td> </tr> </tbody> </table>				Shock Test on Charged Packs											No.	Before			After			Difference			Result	OCV (V)	Resistance(mΩ)	Weight (g)	OCV (V)	Resistance(mΩ)	Weight (g)	Volt (%)	Resistance(%)	Weight (%)	1	1.3609	41.68	248.55	1.355	42.18	248.54	-0.44%	1.20%	0.00%	Pass	2	12.3732	41.03	248.40	12.368	41.53	248.39	-0.04%	1.22%	0.00%	Pass	3	12.3825	42.27	248.58	12.377	42.67	248.57	-0.04%	0.95%	0.00%	Pass	4	12.3782	43.91	248.24	12.372	44.21	248.23	-0.05%	0.68%	0.00%	Pass	5	12.3784	42.57	248.38	12.374	43.07	248.37	-0.03%	1.17%	0.00%	Pass	6	12.3987	42.74	248.35	12.392	43.14	248.35	-0.06%	0.94%	0.00%	Pass	7	12.3839	40.12	248.49	12.378	40.72	248.48	-0.05%	1.50%	0.00%	Pass	8	12.3653	40.55	248.44	12.360	41.05	248.44	-0.04%	1.23%	0.00%	Pass
Shock Test on Charged Packs																																																																																																																											
No.	Before			After			Difference			Result																																																																																																																	
	OCV (V)	Resistance(mΩ)	Weight (g)	OCV (V)	Resistance(mΩ)	Weight (g)	Volt (%)	Resistance(%)	Weight (%)																																																																																																																		
1	1.3609	41.68	248.55	1.355	42.18	248.54	-0.44%	1.20%	0.00%	Pass																																																																																																																	
2	12.3732	41.03	248.40	12.368	41.53	248.39	-0.04%	1.22%	0.00%	Pass																																																																																																																	
3	12.3825	42.27	248.58	12.377	42.67	248.57	-0.04%	0.95%	0.00%	Pass																																																																																																																	
4	12.3782	43.91	248.24	12.372	44.21	248.23	-0.05%	0.68%	0.00%	Pass																																																																																																																	
5	12.3784	42.57	248.38	12.374	43.07	248.37	-0.03%	1.17%	0.00%	Pass																																																																																																																	
6	12.3987	42.74	248.35	12.392	43.14	248.35	-0.06%	0.94%	0.00%	Pass																																																																																																																	
7	12.3839	40.12	248.49	12.378	40.72	248.48	-0.05%	1.50%	0.00%	Pass																																																																																																																	
8	12.3653	40.55	248.44	12.360	41.05	248.44	-0.04%	1.23%	0.00%	Pass																																																																																																																	

Item	Test Item	Test specification	Judge criteria	Sample(s)																																								
T5	Short Circuit Test (UN38.3-5)	5-1.Packs are placed in to a 55±2°C oven, and exterior packs temperature are monitored 5-2.When packs exterior reach 55±2°C, they are shorted by connecting terminals with a copper wire of resistance less than 100m Ohm. 5-4. The short was continued for more than 1hour or the cell temperature return to 55°C. The packs are observed for a further 6 hours.	No rupture, no disassembly, no explosion, no fire, no smoke. Packs exterior peak temperature <170°C.	4 packs are standard charged (Pack#1~4) 4 packs 50 cycled ending in fully charged states (Pack#5~8)																																								
Test Period		S Start: 2014/08/16 End:2014/08/18																																										
Test Equipment		數位電表 Q153, 資料收集器 Q075, 烘箱 Q171																																										
Recommendation		The packs pass the test.																																										
Raw Data		<table border="1"> <thead> <tr> <th colspan="4">Short Circuit Test on Charged Packs</th> </tr> <tr> <th>No.</th> <th>Max. Temp.(°C)</th> <th>Visual</th> <th>Result</th> </tr> </thead> <tbody> <tr><td>1</td><td>56.17</td><td>OK</td><td>Pass</td></tr> <tr><td>2</td><td>55.94</td><td>OK</td><td>Pass</td></tr> <tr><td>3</td><td>55.87</td><td>OK</td><td>Pass</td></tr> <tr><td>4</td><td>55.63</td><td>OK</td><td>Pass</td></tr> <tr><td>5</td><td>55.12</td><td>OK</td><td>Pass</td></tr> <tr><td>6</td><td>55.48</td><td>OK</td><td>Pass</td></tr> <tr><td>7</td><td>55.73</td><td>OK</td><td>Pass</td></tr> <tr><td>8</td><td>55.81</td><td>OK</td><td>Pass</td></tr> </tbody> </table>			Short Circuit Test on Charged Packs				No.	Max. Temp.(°C)	Visual	Result	1	56.17	OK	Pass	2	55.94	OK	Pass	3	55.87	OK	Pass	4	55.63	OK	Pass	5	55.12	OK	Pass	6	55.48	OK	Pass	7	55.73	OK	Pass	8	55.81	OK	Pass
Short Circuit Test on Charged Packs																																												
No.	Max. Temp.(°C)	Visual	Result																																									
1	56.17	OK	Pass																																									
2	55.94	OK	Pass																																									
3	55.87	OK	Pass																																									
4	55.63	OK	Pass																																									
5	55.12	OK	Pass																																									
6	55.48	OK	Pass																																									
7	55.73	OK	Pass																																									
8	55.81	OK	Pass																																									
Item	Test Item	Test specification	Judge criteria	Sample(s)																																								
T6	Crush test/ Impact test (UN38.3-6)	6-1.Cell's diameter > 20mm, Execution impact test. (A 9.1 Kg mass is to be dropped from a height of 61±2.5cm onto the sample.) 6-2.Cell's diameter < 20mm, Execution crush test (The cells are crushed with a 13 KN with the crush tester. Once the force is obtained it is to be released.)	External temperature of cell does not exceed 170°C and there is no disassembly and no fire within 6 hours of the test.	5 cells are 50% charged (Cell #1~5)																																								
Test Period		Start: 2014/08/08 End:2014/02/08																																										
Test Equipment		數位電表 Q153, 資料收集器 Q152, 擠壓試驗機 Q437																																										
Recommendation		The Cells pass the test.																																										
Raw Data		<table border="1"> <thead> <tr> <th colspan="4">Crush Test on 50% Charged Cells</th> </tr> <tr> <th>No.</th> <th>Max. Temp.(°C)</th> <th>Visual</th> <th>Result</th> </tr> </thead> <tbody> <tr><td>1</td><td>76.89</td><td>OK</td><td>Pass</td></tr> <tr><td>2</td><td>84.55</td><td>OK</td><td>Pass</td></tr> <tr><td>3</td><td>92.37</td><td>OK</td><td>Pass</td></tr> <tr><td>4</td><td>91.28</td><td>OK</td><td>Pass</td></tr> <tr><td>5</td><td>87.43</td><td>OK</td><td>Pass</td></tr> </tbody> </table>			Crush Test on 50% Charged Cells				No.	Max. Temp.(°C)	Visual	Result	1	76.89	OK	Pass	2	84.55	OK	Pass	3	92.37	OK	Pass	4	91.28	OK	Pass	5	87.43	OK	Pass												
Crush Test on 50% Charged Cells																																												
No.	Max. Temp.(°C)	Visual	Result																																									
1	76.89	OK	Pass																																									
2	84.55	OK	Pass																																									
3	92.37	OK	Pass																																									
4	91.28	OK	Pass																																									
5	87.43	OK	Pass																																									

Item	Test Item	Test specification	Judge criteria	Sample(s)																																														
T7	Overcharge test (UN38.3-7)	7-1. The charge current shall be twice the Spec's recommended maximum continuous charge current. 7-2. The minimum voltage of the test shall be as follows: (a) When the Spec's recommended charge voltage is not more than 18V, the minimum voltage of the test shall be the lesser of two times the maximum charge voltage of the battery or 22V. (b) When the Spec's recommended charge voltage is more than 18V, the minimum voltage of the test shall be 1.2 times the maximum charge voltage. 7-3. Tests are to be conducted at ambient temperature. The duration of the test shall be 24 hours.	No disassembly, no fire within seven days after the test.	4 packs are fully charged (Pack#9~12) 4 packs are 50 times cycled ending in fully charged state (Pack #13~16)																																														
Test Period		Start: 2014/08/11 End:2014/08/14																																																
Test Equipment		數位電表 Q153, 資料收集器 Q078, 電源供應器 Q148/Q149/Q150																																																
Major Problem		-																																																
Warning Point		-																																																
Recommendation		The packs pass the test.																																																
Raw Data		<table border="1"> <thead> <tr> <th colspan="6">Overcharge Test on Charged Packs</th> </tr> <tr> <th>No.</th> <th>Charge Voltage(V)</th> <th>Charge Current(A)</th> <th>Max. Temp.(°C)</th> <th>Visual</th> <th>Result</th> </tr> </thead> <tbody> <tr> <td>9</td> <td rowspan="8">22.0 V</td> <td rowspan="8">2.7</td> <td>20.11</td> <td>OK</td> <td>Pass</td> </tr> <tr> <td>10</td> <td>20.56</td> <td>OK</td> <td>Pass</td> </tr> <tr> <td>11</td> <td>21.14</td> <td>OK</td> <td>Pass</td> </tr> <tr> <td>12</td> <td>21.36</td> <td>OK</td> <td>Pass</td> </tr> <tr> <td>13</td> <td>20.84</td> <td>OK</td> <td>Pass</td> </tr> <tr> <td>14</td> <td>20.93</td> <td>OK</td> <td>Pass</td> </tr> <tr> <td>15</td> <td>20.72</td> <td>OK</td> <td>Pass</td> </tr> <tr> <td>16</td> <td>20.59</td> <td>OK</td> <td>Pass</td> </tr> </tbody> </table>			Overcharge Test on Charged Packs						No.	Charge Voltage(V)	Charge Current(A)	Max. Temp.(°C)	Visual	Result	9	22.0 V	2.7	20.11	OK	Pass	10	20.56	OK	Pass	11	21.14	OK	Pass	12	21.36	OK	Pass	13	20.84	OK	Pass	14	20.93	OK	Pass	15	20.72	OK	Pass	16	20.59	OK	Pass
Overcharge Test on Charged Packs																																																		
No.	Charge Voltage(V)	Charge Current(A)	Max. Temp.(°C)	Visual	Result																																													
9	22.0 V	2.7	20.11	OK	Pass																																													
10			20.56	OK	Pass																																													
11			21.14	OK	Pass																																													
12			21.36	OK	Pass																																													
13			20.84	OK	Pass																																													
14			20.93	OK	Pass																																													
15			20.72	OK	Pass																																													
16			20.59	OK	Pass																																													

Item	Test Item	Test specification	Judge criteria	Sample(s)																																																																																																	
T8	Forced discharge test (UN38.3-8)	Cell shall be forced discharged at ambient temperature by connecting it in series with a 12 V D.C. power supply at an initial current equal to the maximum discharge current Specified by the manufacturer.	No disassembly, no fire within seven days after the test.	10 cells are first cycle in fully discharged states (Pack#6~15) 10 cells are after 50 cycles ending in fully discharged states (Pack #16~25)																																																																																																	
Test Period		Start: 2014/08/11 End:2014/08/13																																																																																																			
Test Equipment		數位電表 Q153, 資料收集器 Q160, 電源供應器 Q147/Q236/Q237																																																																																																			
Major Problem		-																																																																																																			
Warning Point		-																																																																																																			
Recommendation		The packs pass the test.																																																																																																			
Raw Data		<table border="1"> <thead> <tr> <th colspan="4">Forced discharge are first cycle in fully discharged</th> <th colspan="4">Forced discharge are after 50 cycles ending in fully discharged</th> </tr> <tr> <th>No.</th> <th>Max. Temp.(°C)</th> <th>Visual</th> <th>Result</th> <th>No.</th> <th>Max. Temp.(°C)</th> <th>Visual</th> <th>Result</th> </tr> </thead> <tbody> <tr> <td>6</td> <td>82.35</td> <td>OK</td> <td>Pass</td> <td>16</td> <td>93.16</td> <td>OK</td> <td>Pass</td> </tr> <tr> <td>7</td> <td>78.94</td> <td>OK</td> <td>Pass</td> <td>17</td> <td>95.68</td> <td>OK</td> <td>Pass</td> </tr> <tr> <td>8</td> <td>64.33</td> <td>OK</td> <td>Pass</td> <td>18</td> <td>98.24</td> <td>OK</td> <td>Pass</td> </tr> <tr> <td>9</td> <td>92.34</td> <td>OK</td> <td>Pass</td> <td>19</td> <td>88.51</td> <td>OK</td> <td>Pass</td> </tr> <tr> <td>10</td> <td>81.12</td> <td>OK</td> <td>Pass</td> <td>20</td> <td>84.36</td> <td>OK</td> <td>Pass</td> </tr> <tr> <td>11</td> <td>85.63</td> <td>OK</td> <td>Pass</td> <td>21</td> <td>102.34</td> <td>OK</td> <td>Pass</td> </tr> <tr> <td>12</td> <td>79.45</td> <td>OK</td> <td>Pass</td> <td>22</td> <td>100.45</td> <td>OK</td> <td>Pass</td> </tr> <tr> <td>13</td> <td>80.53</td> <td>OK</td> <td>Pass</td> <td>23</td> <td>99.87</td> <td>OK</td> <td>Pass</td> </tr> <tr> <td>14</td> <td>77.47</td> <td>OK</td> <td>Pass</td> <td>24</td> <td>84.17</td> <td>OK</td> <td>Pass</td> </tr> <tr> <td>15</td> <td>91.24</td> <td>OK</td> <td>Pass</td> <td>25</td> <td>86.29</td> <td>OK</td> <td>Pass</td> </tr> </tbody> </table>				Forced discharge are first cycle in fully discharged				Forced discharge are after 50 cycles ending in fully discharged				No.	Max. Temp.(°C)	Visual	Result	No.	Max. Temp.(°C)	Visual	Result	6	82.35	OK	Pass	16	93.16	OK	Pass	7	78.94	OK	Pass	17	95.68	OK	Pass	8	64.33	OK	Pass	18	98.24	OK	Pass	9	92.34	OK	Pass	19	88.51	OK	Pass	10	81.12	OK	Pass	20	84.36	OK	Pass	11	85.63	OK	Pass	21	102.34	OK	Pass	12	79.45	OK	Pass	22	100.45	OK	Pass	13	80.53	OK	Pass	23	99.87	OK	Pass	14	77.47	OK	Pass	24	84.17	OK	Pass	15	91.24	OK	Pass	25	86.29	OK	Pass
Forced discharge are first cycle in fully discharged				Forced discharge are after 50 cycles ending in fully discharged																																																																																																	
No.	Max. Temp.(°C)	Visual	Result	No.	Max. Temp.(°C)	Visual	Result																																																																																														
6	82.35	OK	Pass	16	93.16	OK	Pass																																																																																														
7	78.94	OK	Pass	17	95.68	OK	Pass																																																																																														
8	64.33	OK	Pass	18	98.24	OK	Pass																																																																																														
9	92.34	OK	Pass	19	88.51	OK	Pass																																																																																														
10	81.12	OK	Pass	20	84.36	OK	Pass																																																																																														
11	85.63	OK	Pass	21	102.34	OK	Pass																																																																																														
12	79.45	OK	Pass	22	100.45	OK	Pass																																																																																														
13	80.53	OK	Pass	23	99.87	OK	Pass																																																																																														
14	77.47	OK	Pass	24	84.17	OK	Pass																																																																																														
15	91.24	OK	Pass	25	86.29	OK	Pass																																																																																														