

*Lounge-Anbau 1 für Malta 3*

*Art. Nr. 993300*

*993300002 / 993300003 / 993300004 / 993300005*

*1/8*

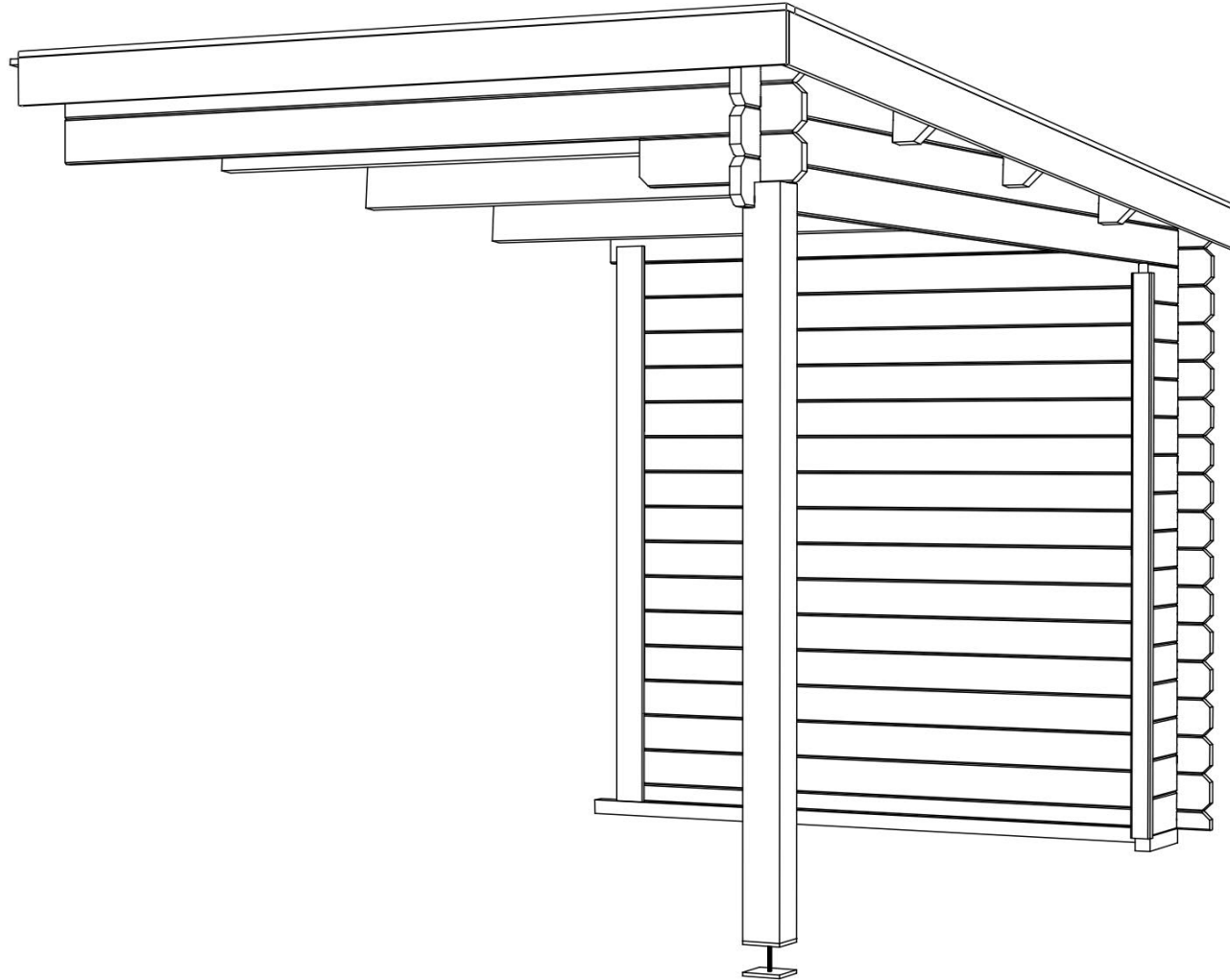

H€1€201ï

Art. Nr. 993300  
993300002 / 993300003 / 993300004 / 993300005

Groundplan - Grundplan - Plan de masse - Planimetria -  
Plattegrond - Põhiplaan

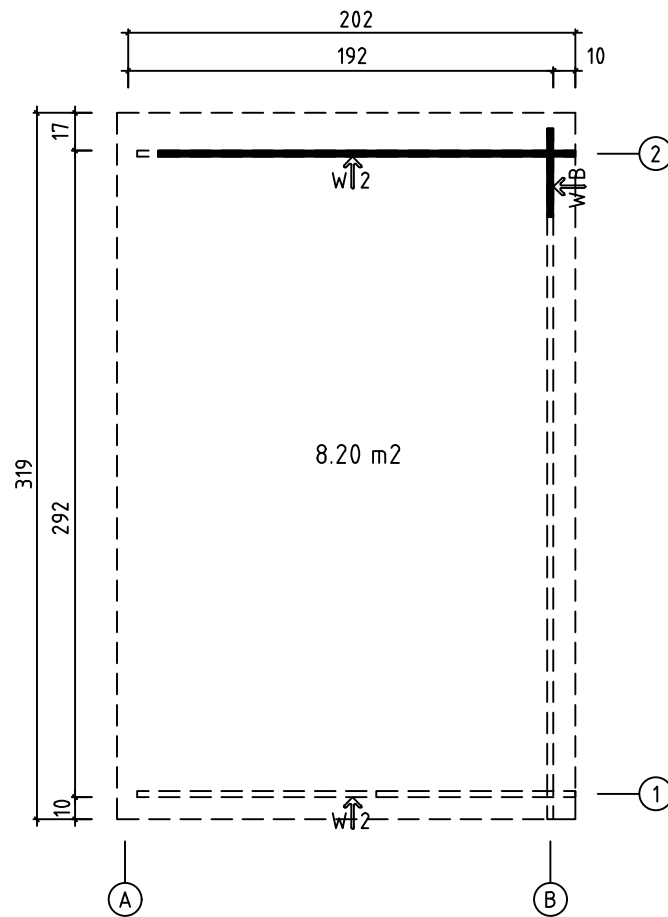

Foundation - Fundament - Fondation - Fondamenta - Fundering -  
Immutatud alusraam

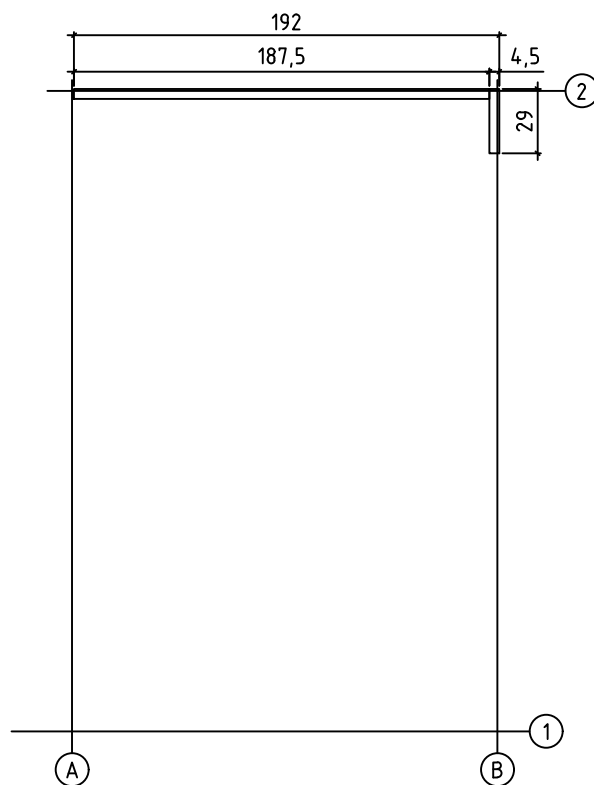

Art. Nr. 993300  
993300002 / 993300003 / 993300004 / 993300005

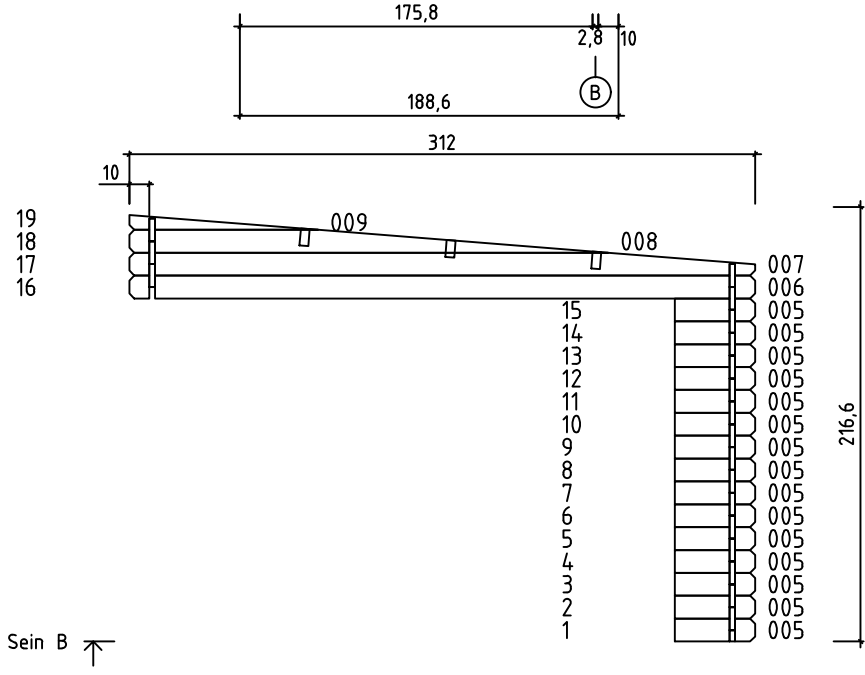
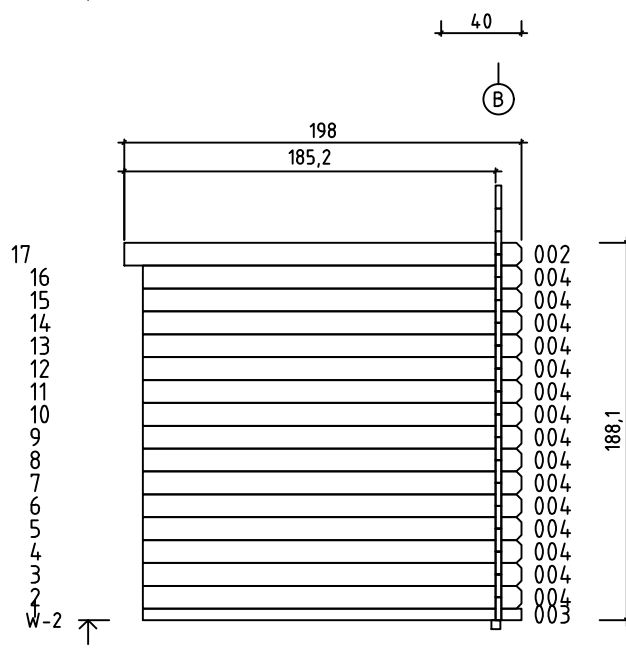
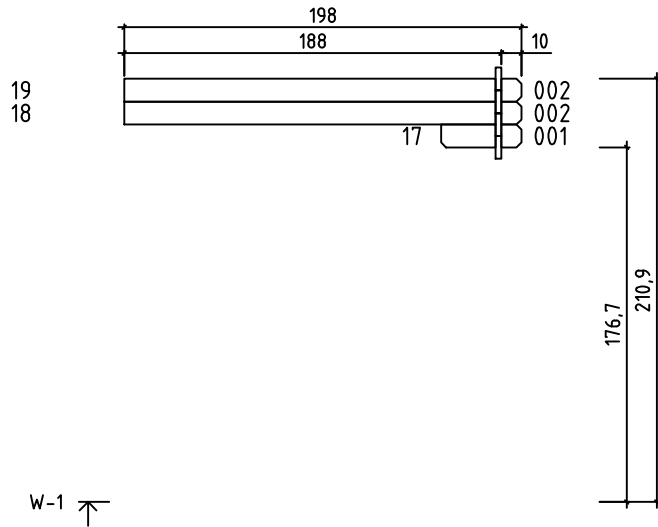

Art. Nr. 993300  
993300002 / 993300003  
993300004 / 993300005

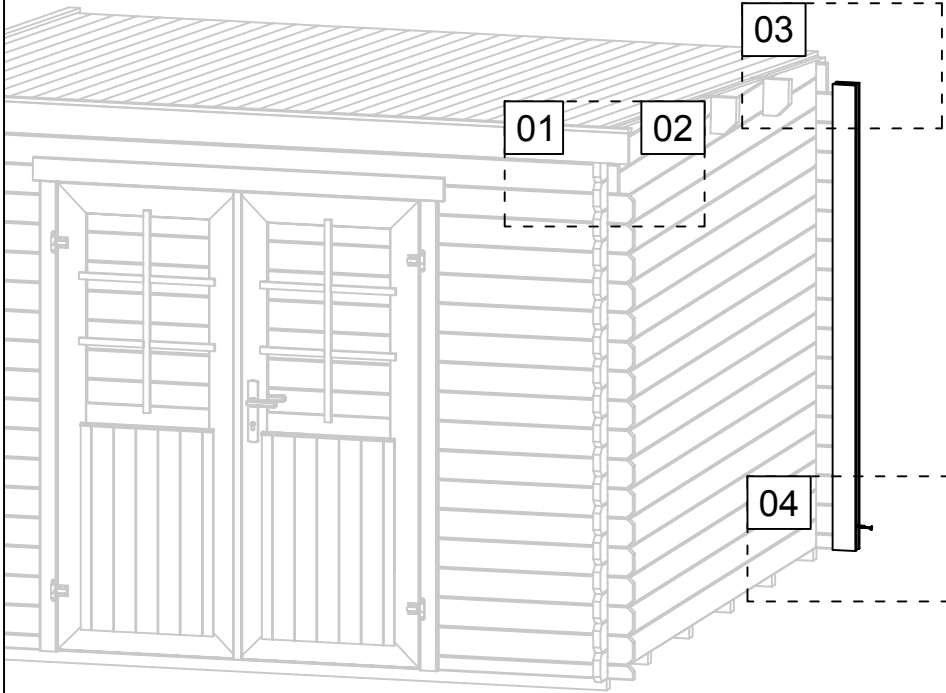

01

14

Malta 3  
TB

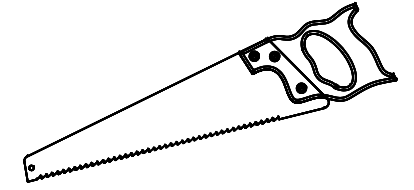

02

40

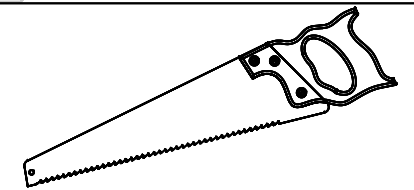
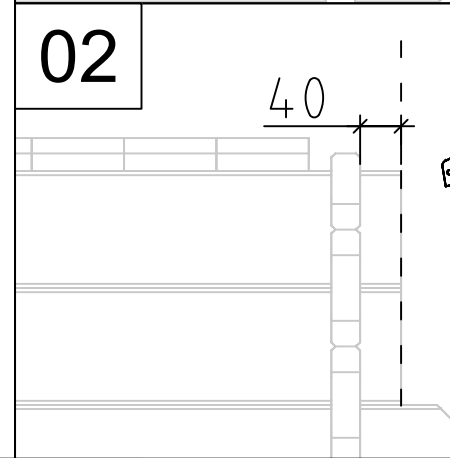

04

HP

HS13

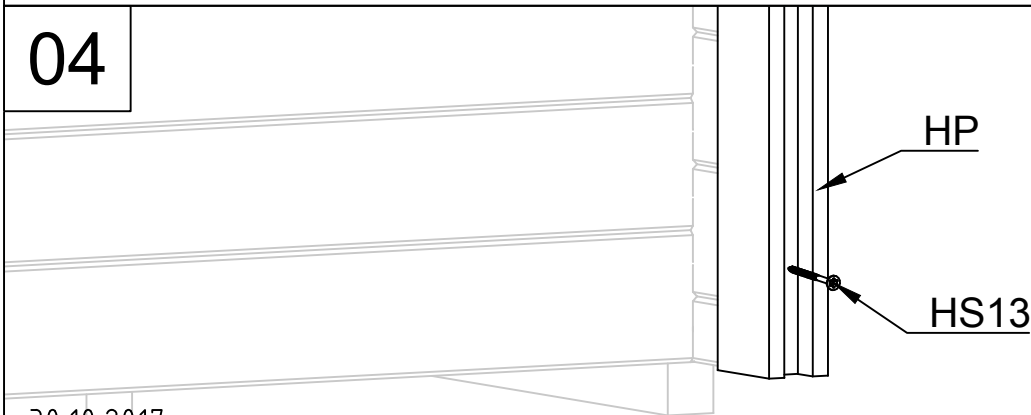

03

40

GL

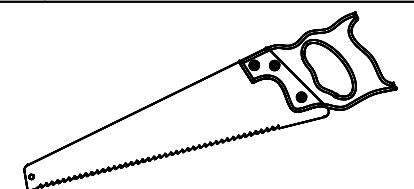
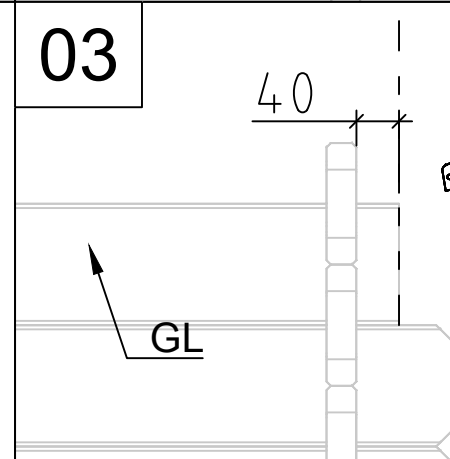

Art. Nr. 993300  
993300002 / 993300003  
993300004 / 993300005

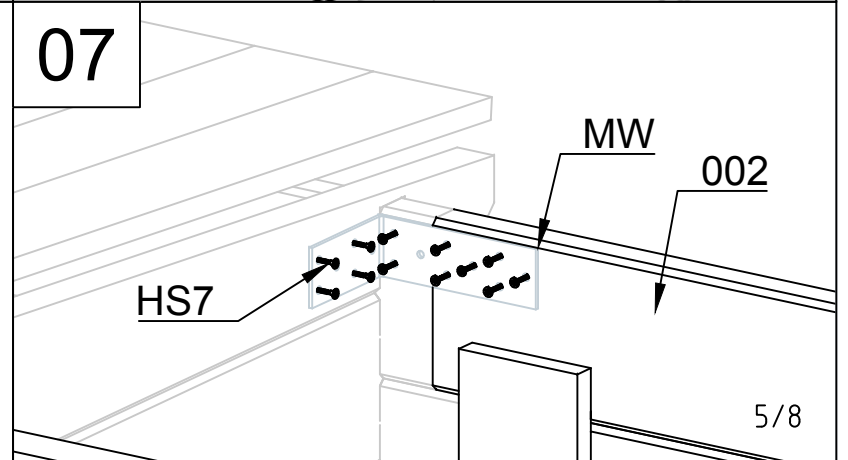
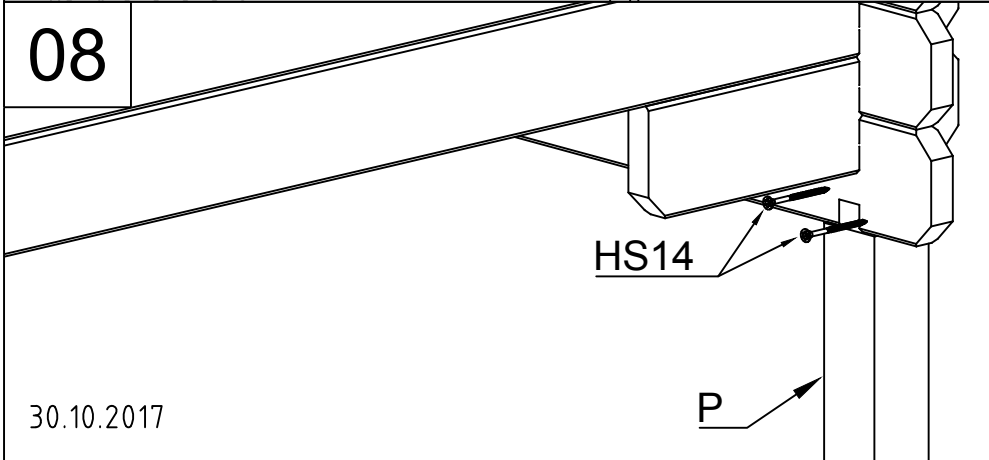
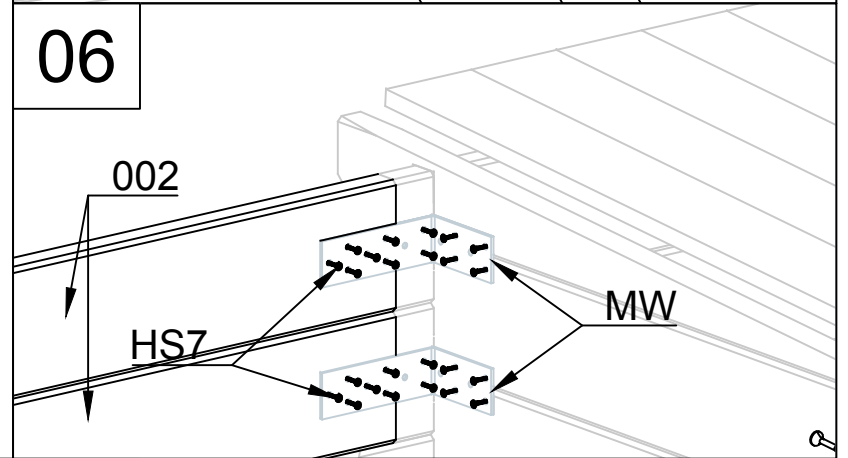
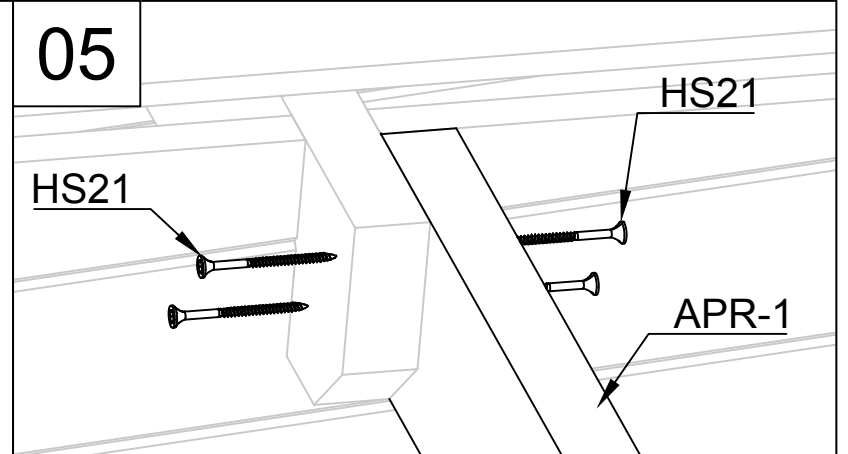
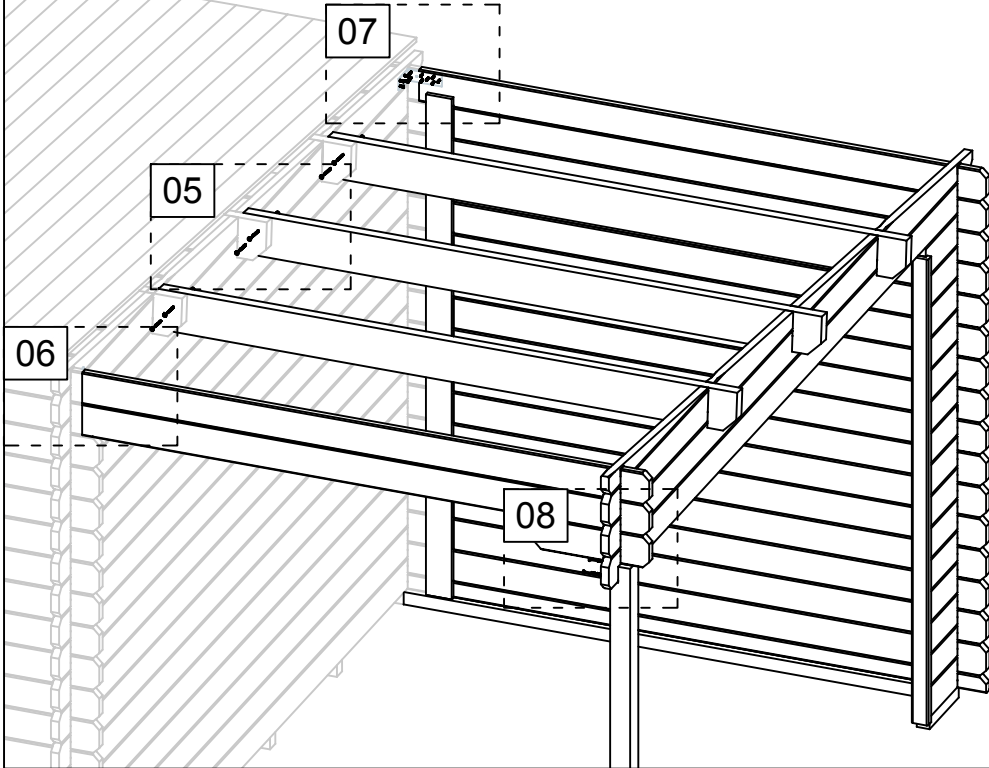

Art. Nr. 993300  
993300002 / 993300003  
993300004 / 993300005











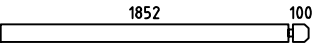
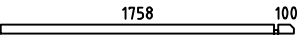
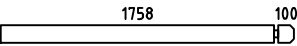

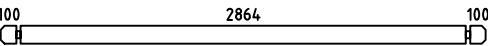
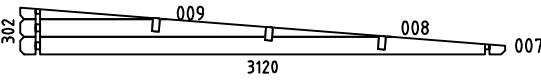
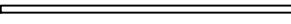

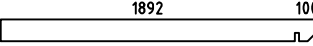
09

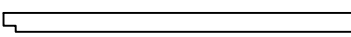
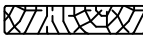
HS12

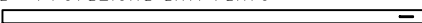
TB

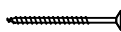
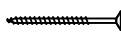
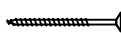
30.10.2017

Pos	Piece list - Stückliste - Liste des pièces - Elementi - Stuklijst - Tükitalabel 30.10.2017 Art. Nr. 993300 993300002 / 993300003 / 993300004 / 993300005	7/8	Q	P (mm)	L (mm)
001			1	28x114	400
002			3	28x114	1980
003			1	28x57	1886
004			15	28x114	1886
005			15	28x114	400
006			1	28x114	3120
WB-1			1		
IAR2	Foundation - Fundament - Fondation - Fondamenta - Fundering - Immutatud alusraam 		1	45x45	1875
IAR1	Foundation - Fundament - Fondation - Fondamenta - Fundering - Immutatud alusraam 		1	45x45	290
A-PR1	Roof beam - Dachbalken - Panne de toit - Perlina del tetto - Gordingen / dakbalk - Pärilin 		3	44x140	2020
	Roof boards - Dachbretter - Voliges - Perlina per tetto - Dakhout - Katuselaud 		35	90x15	3200
	Roofing felt fillet - Dachpappenleiste - Baguette de fixation du feutre bitumeux - Asse per fissaggio guaina bituminosa - Afdekljst asfaltpapier - Katusepapiilist 		1	15x45	1920
P	Post - Pfosten - Poteau - Piede registrabile - Stijl - Post 		1	70x70	1662
TB	Fascia board - Traufbrett - Bandeau de toit - Finitura lati tetto - Gevellijst - Räästalaud 		1	15x120	2049
DRV1	Roof edge reinforcement - Dachrandverstärkung - Corniere de renfort de bord de toit - Rinforzo x tetto - Dakrand versterking - Räästatugevdus 		1	15x45	1920
KFS-1	Storm protection - Sturmleiste - Latte anti-tempete - Protezione anti vento - Stormverankering / beveliging - Tormikinnitusliist 		1	22x45	2050
UP	U-profile - U-profils - Profile u - Profilo ad u - U-profiel - U-profiil 		1	28x58	1680
HP	H-profile - H-profils - Profile H - Profilo ad H - H-profiel - H-profiil 		1	58x90	1805
HS7	Screw for metal corner - Holzschraube für metallwinkel - Vis de fixation des cornieres en métal - Viti per fissare suadretta di metallo di giunzione - Schroef voor metalen hoek - Kruvi nurgikule 		36	2.5x20	
HS9	Screw for u-profile - Schraube zur befestigung u-profils - Vis a tete fraisée pour profil u - Vite per profilo ad u - Schroef ter bevestiging u-profiel - Kruvi U-profiilile 		3	3.5x50	
HS4	Screw for roof edge reinforcement - Schrauben für dachrandverstärkung - Vis pour fixation corniere renfort de bord de toit - Viti x rinforzo bordo tetto - Schroef voor dakrand versterking - Kruvi räästatugevdusele 		5	3x30	
HS12	Screw for fascia boards - Schrauben für traufbretter - Vis pour fixation bandeau de toit - Viti x striscia del tetto - Schroef voor gevellijst - Kruvi räästalauale 		8	4x40	
HS13	Screw for post - Schrauben für pfosten - Vis de fixation des poteaux - Viti per inviare - Schroef voor stijlen - Kruvi postile 		2	4x60	

