

7788

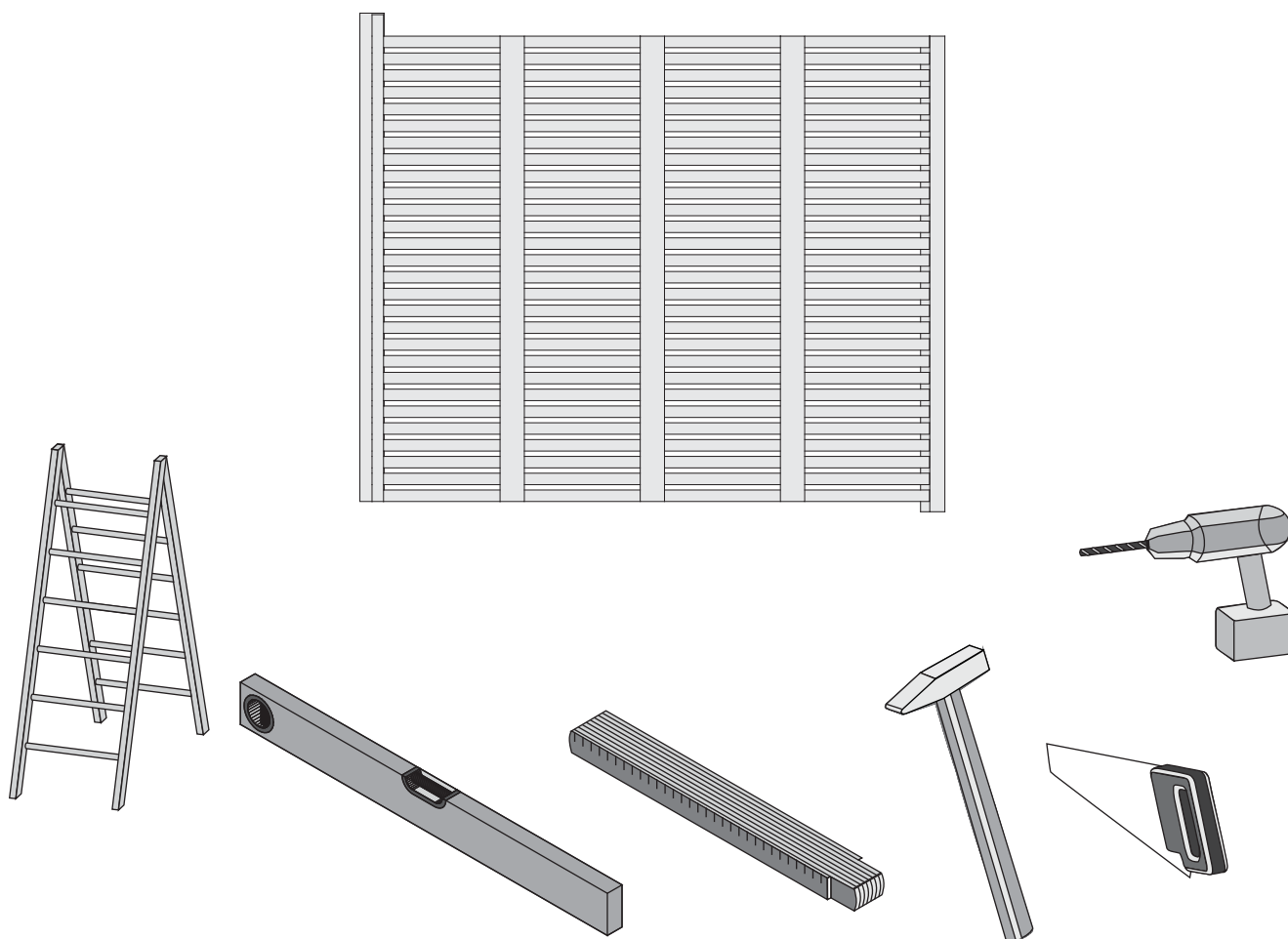

 **Aufbauanleitung**

 **Building Instructions**

 **notice de montage**

 **montagehandleiding**

 **Montagevejledning**

 **Instrucciones de construcción**

 **Istruzioni per il montaggio**

 **Montážní návod**





**+49 421 38693 33**

 Vergleichen Sie zuerst die Material-liste mit Ihrem Paketinhalt! Bitte haben Sie Verständnis, dass Beanstandungen nur im nicht aufgebauten Zustand bearbeitet werden können!

 Vergelijk eerst de lijst van materialen met de inhoud van uw pakket! Reclamaties kunnen alleen in behandeling worden genomen zolang de onderdelen nog niet zijn gemonteerd!

 Confrontate questa distinta materiali prima con il contenuto del pacchetto! Vi preghiamo di comprendere che eventuali reclami possono essere accolti solo prima del montaggio!

 First compare the list of materials with your package contents! Please understand that complaints can be processed in the non-built status only!

 Start med at kontrollere materialelisten med indholdet af den leverede pakke! Vi gør venligst opmærksom på at reklamationer kun kan behandles for materialer som ikke er blevet bearbejdet!

 Nejprve přezkontrolujte obsah balení podle materiálového listu! Mějte pochopení pro to, že případnou reklamaci se můžeme zabývat pouze tehdy, když díly nebudou smontované! Za pomoci tohoto seznamu můžete jednotlivé díly přiřadit k montážnímu návodu.

 Commencez par comparer la liste du matériel avec le contenu de votre paquet! Sachez que nous traitons uniquement les réclamations concernant le matériel à l'état non monté!

 En primer lugar, compare la lista de material con el contenido del paquete. Rogamos entienda que las reclamaciones sólo pueden ser tramitadas antes de montar el objeto!

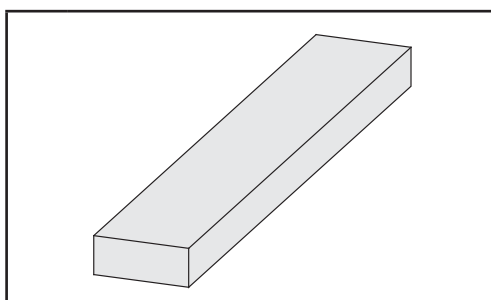
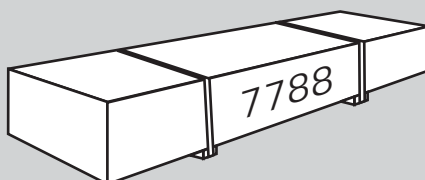

28 x Z1	2180 x 45 x 18 mm	ID 10039
1 x Z2	1880 x 58 x 18 mm	ID 67644
6 x Z3	1820 x 95 x 18 mm	ID 18165
2 x Z4	1990 x 95 x 18 mm	ID 15983
1 x Z5	1950 x 45 x 38 mm	ID 41511

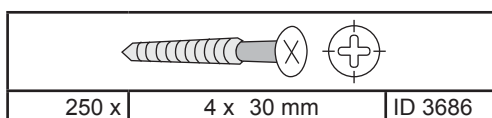

\*

 Nicht im Lieferumfang enthalten

 No forman parte del suministro

 Not included

 Non incluso

 Non comprises dans la livraison



 V ceně není zahrnuto

 Niet bijgeleverd

 Ikke inkluderet

 Übersicht  
 Overview  
 enquête

 overzicht  
 undersøgelse  
 estudio

 sondaggio  
 přehled

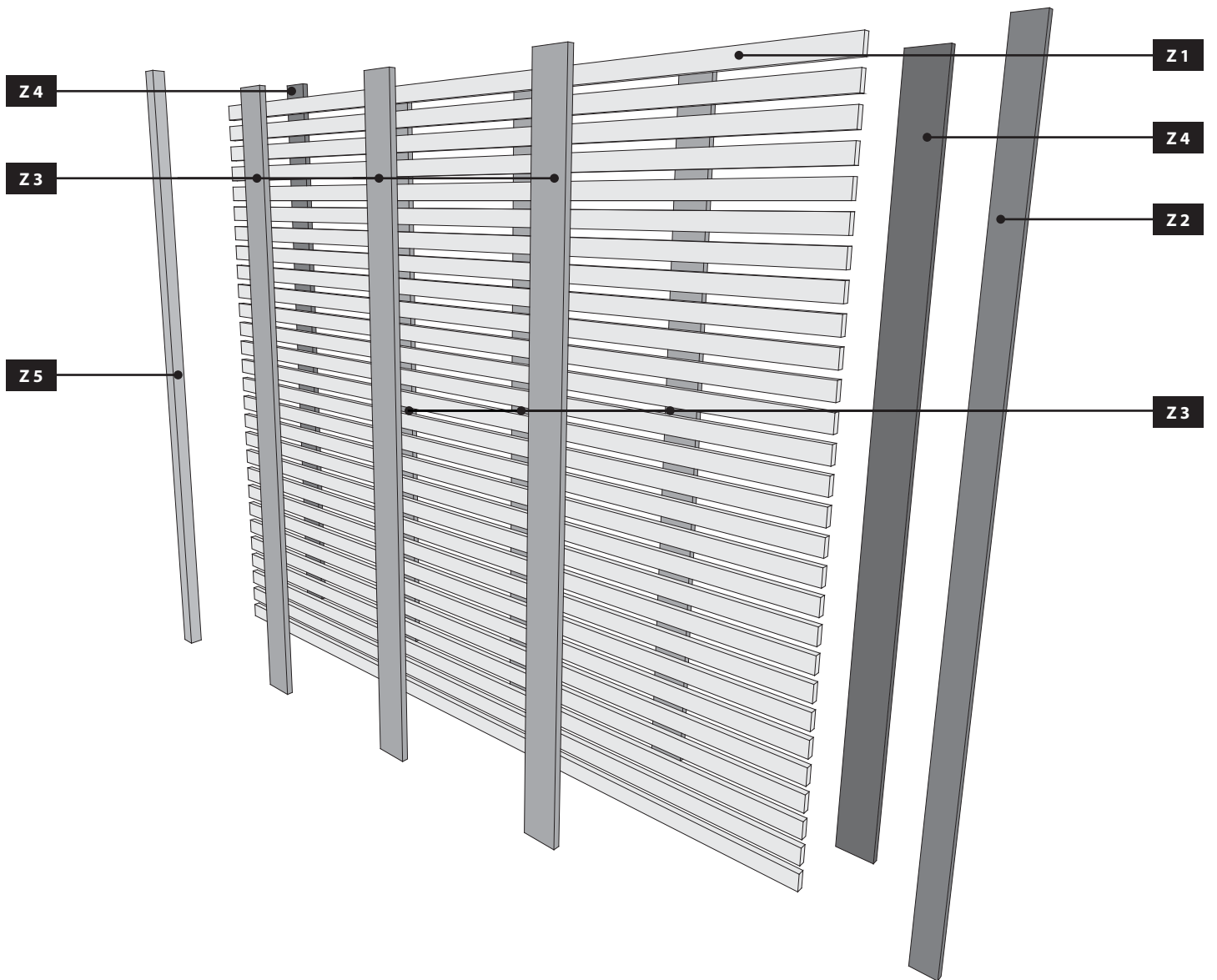

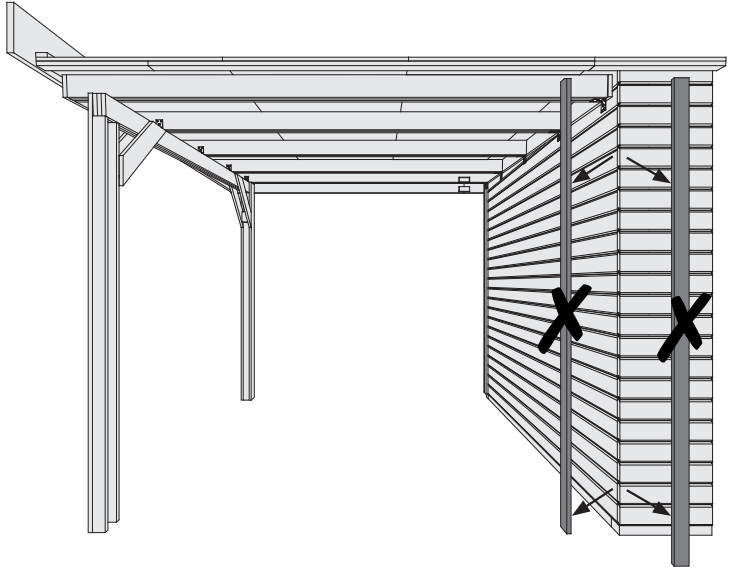

-  Länge muss ermittelt und zugesägt werden
-  La longitud debe ser determinada y aserrada
-  Length must be determined and sawn
-  La lunghezza deve essere determinata e segata
-  La longueur doit être déterminée et sciée
-  Délka musí být určena a rozřezána
-  De lengte moet worden bepaald en worden gezaagd
-  Længden skal bestemmes og saves

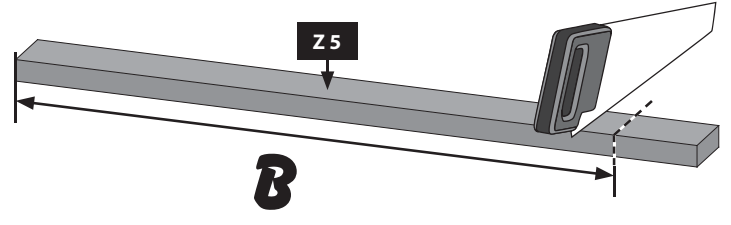
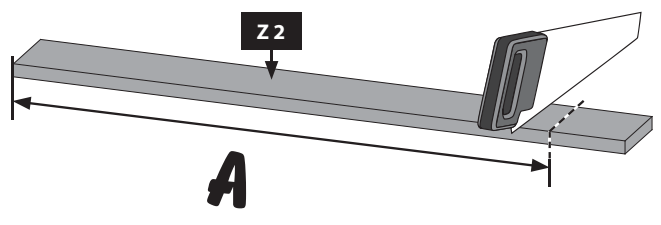
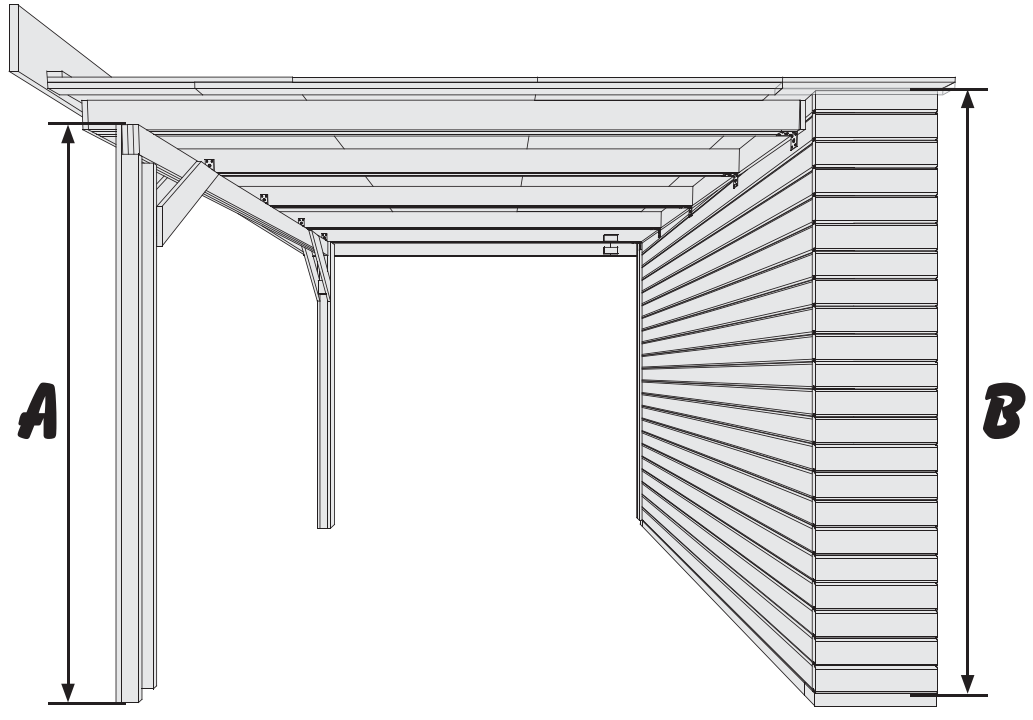
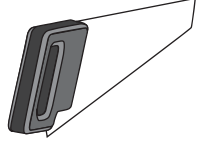
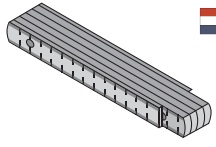

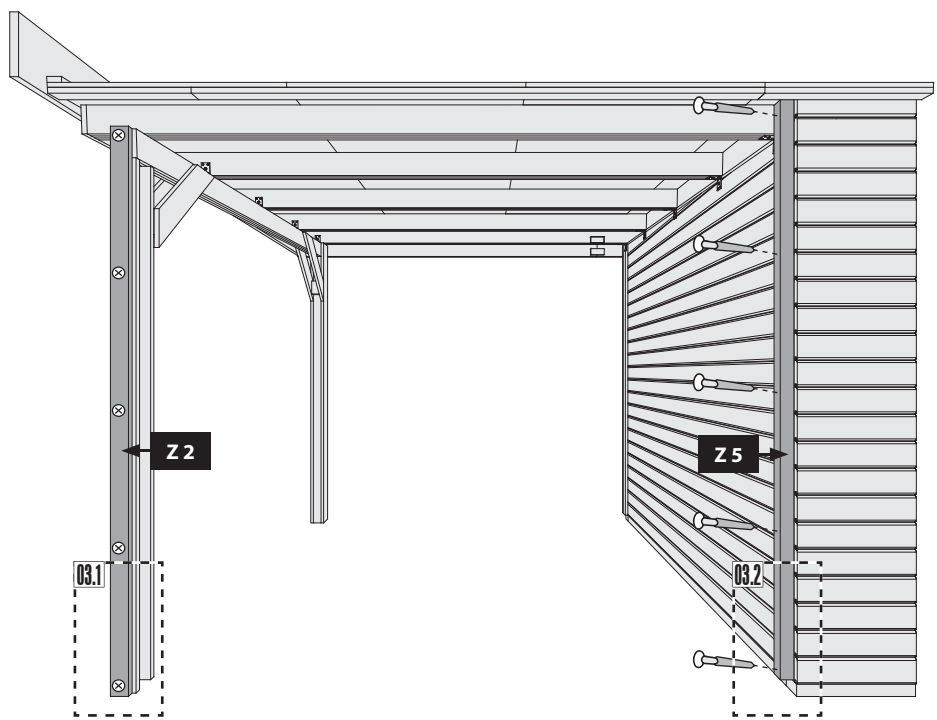

03.1

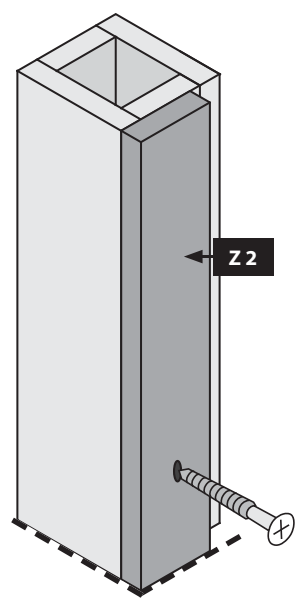

03.2

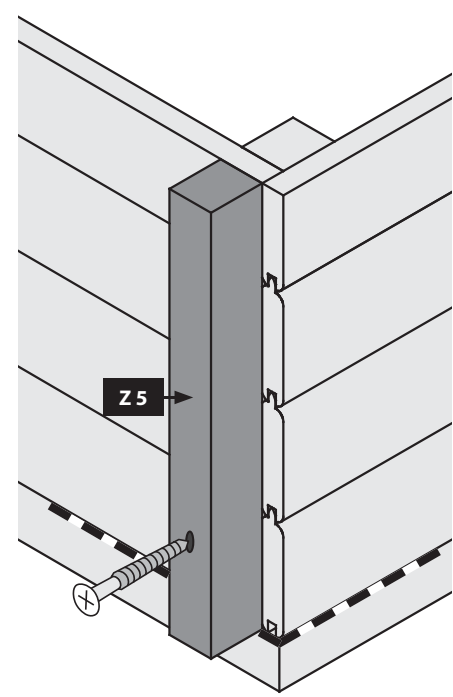

-  Bündig!
-  Flush!
-  Affleurement!
-  Gelijk!
-  I flugt!
-  Aras!
-  Combacia!
-  Stejný !

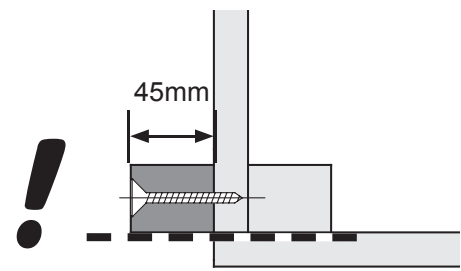
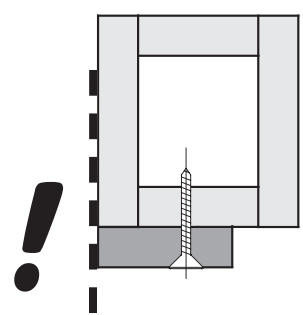

04

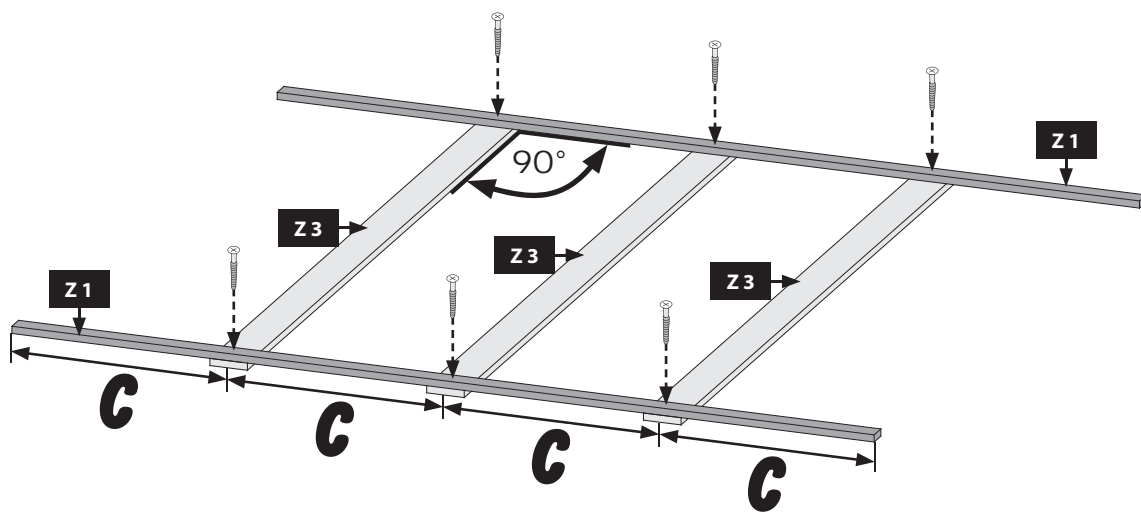

Ø3 mm 4x30

6x

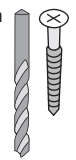

05

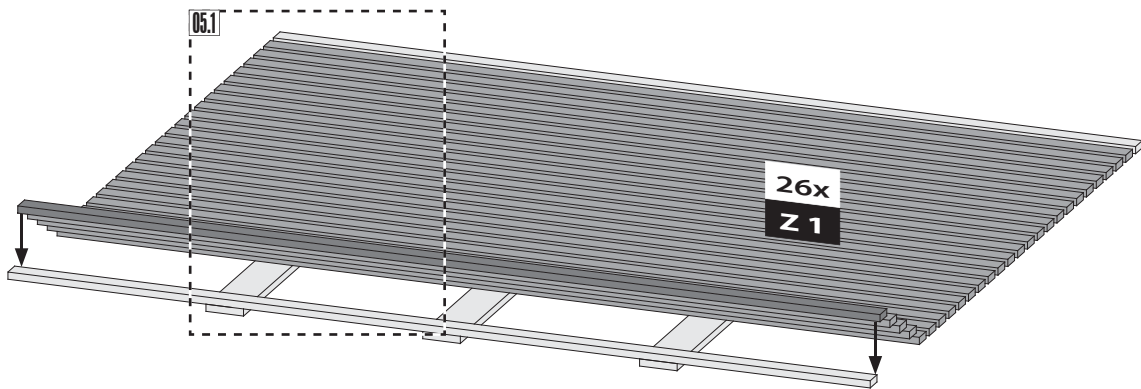

Ø3 mm 4x30

78x

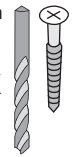

05.1

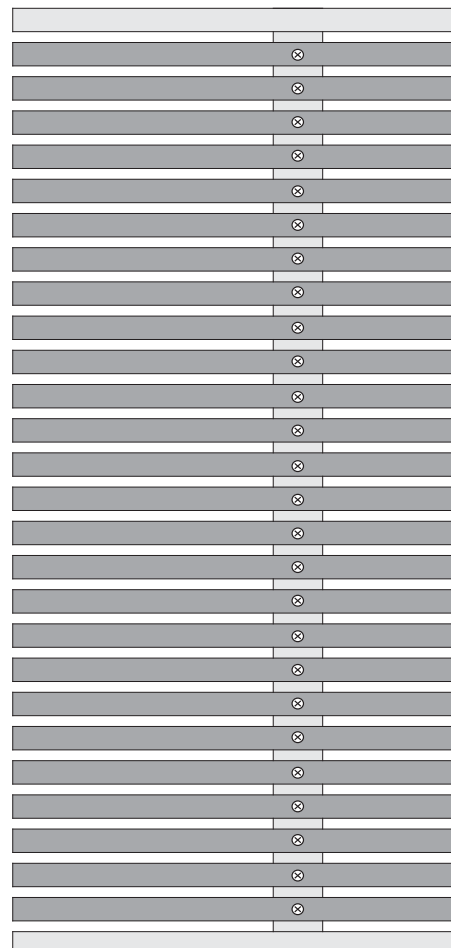
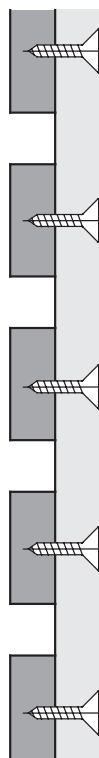
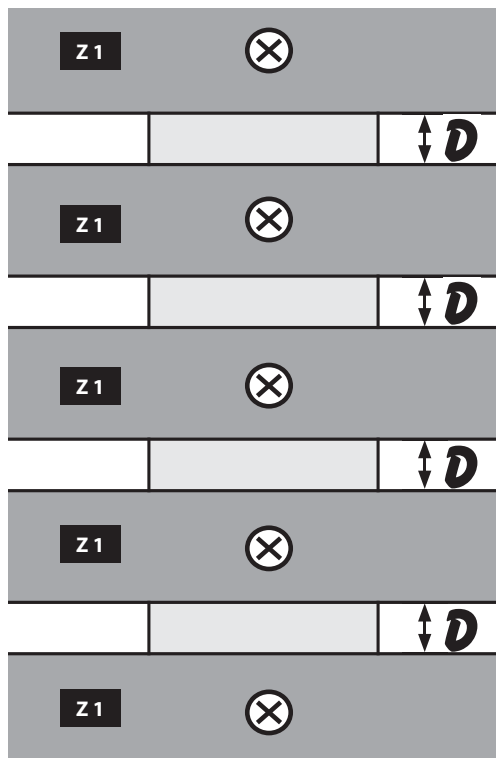

06

Ø3 mm 4x30

56x

06.1

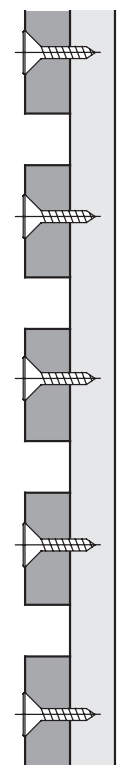
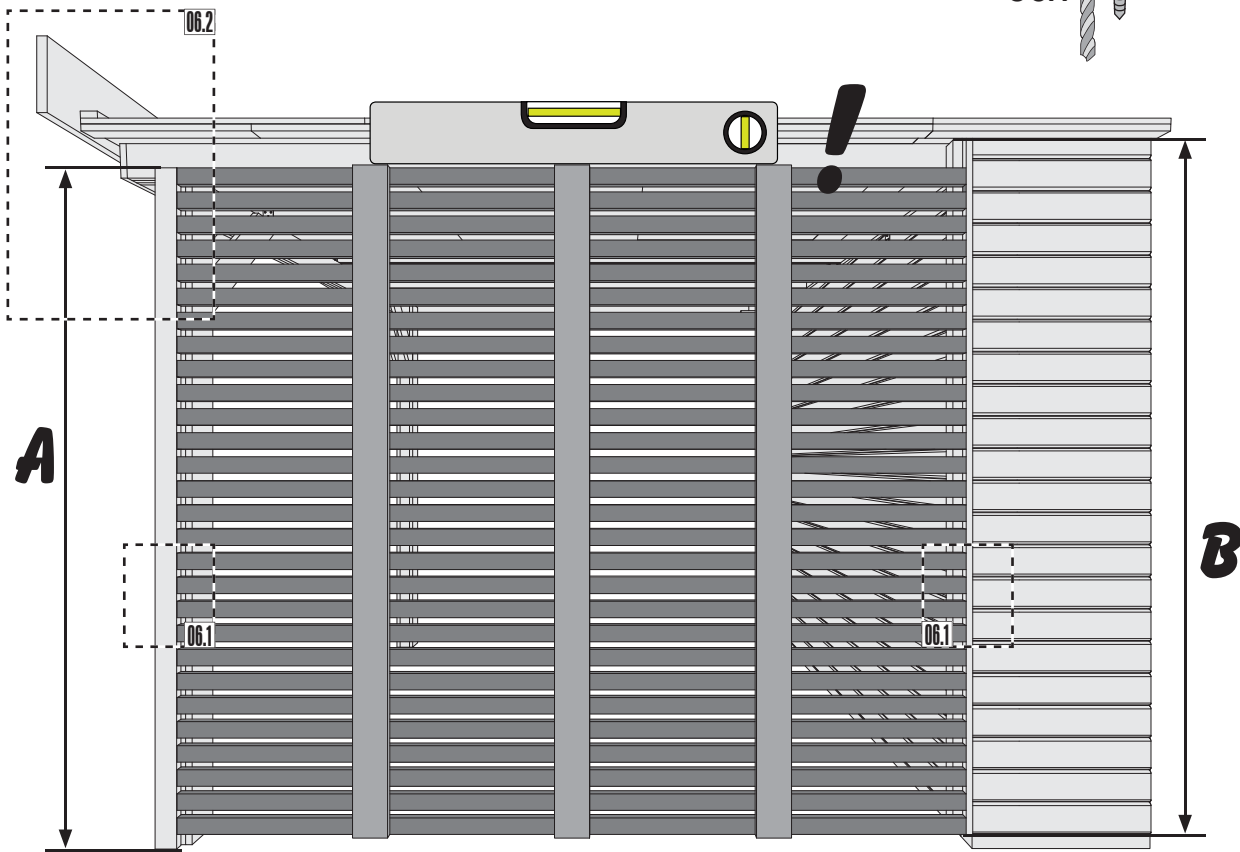

06.2

-  Bündig!
-  Flush!
-  Affleurement!
-  Gelijk!
-  I flugt!
-  Aras!
-  Combacia!
-  Stejný !

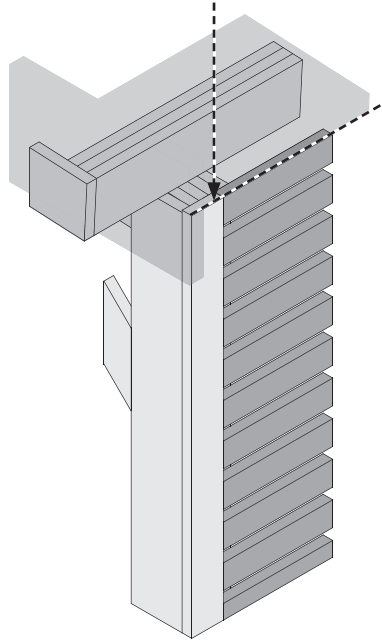

07

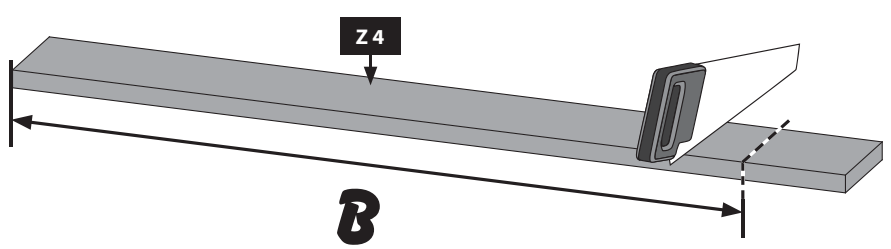
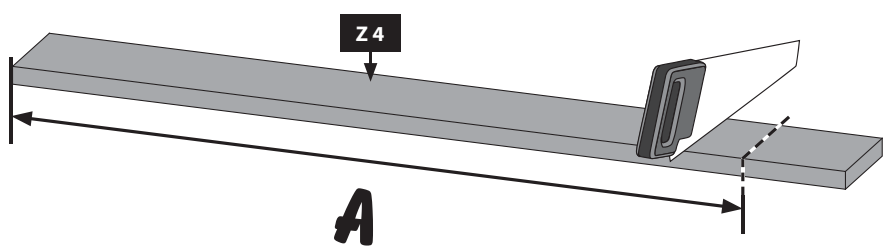
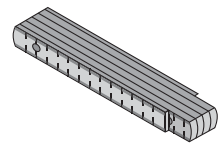

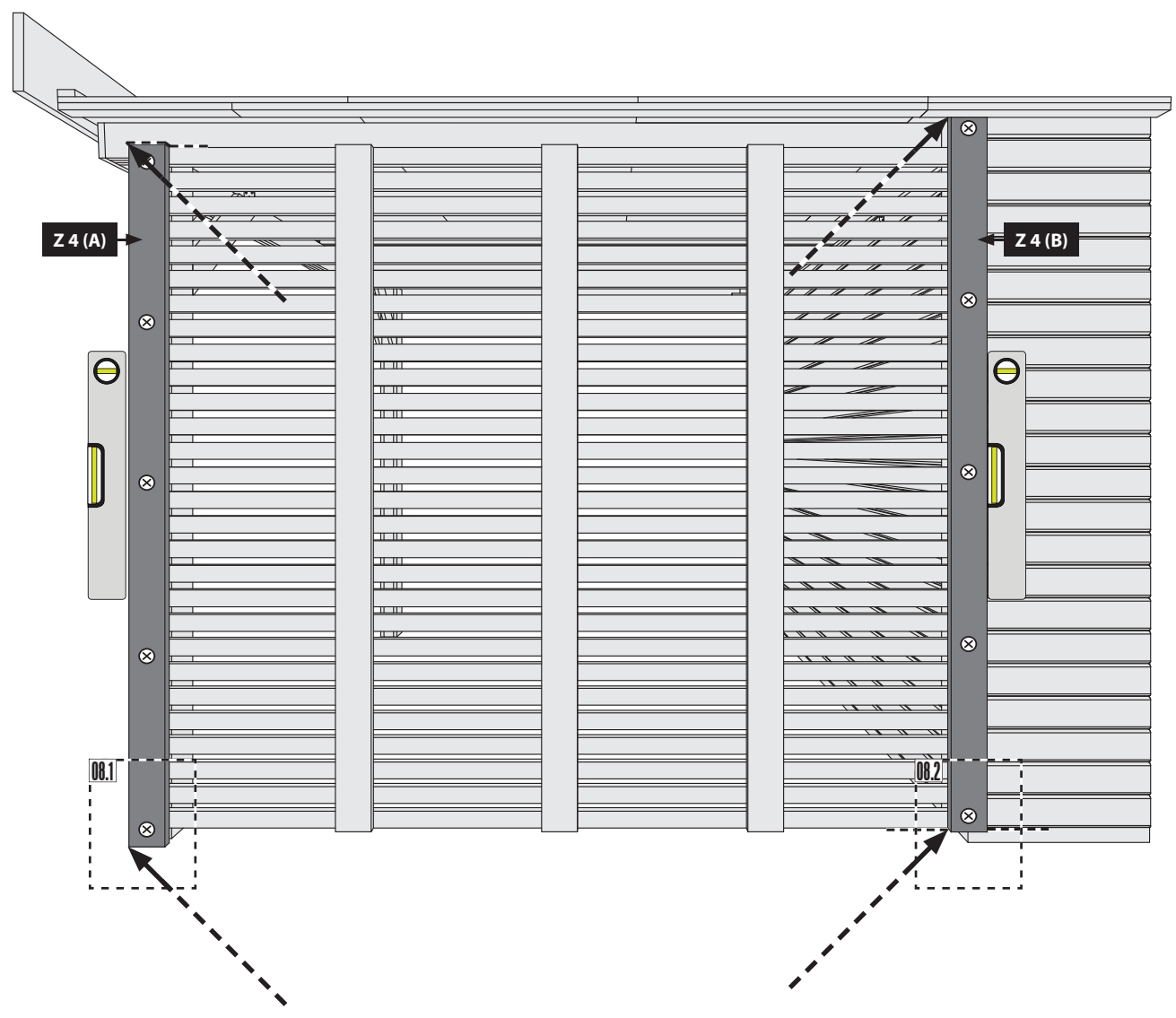
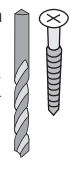

-  Bündig!
-  Flush!
-  Affleurement!
-  Gelijk!
-  I flugt!
-  Aras!
-  Combacia!
-  Stejný !

08.1

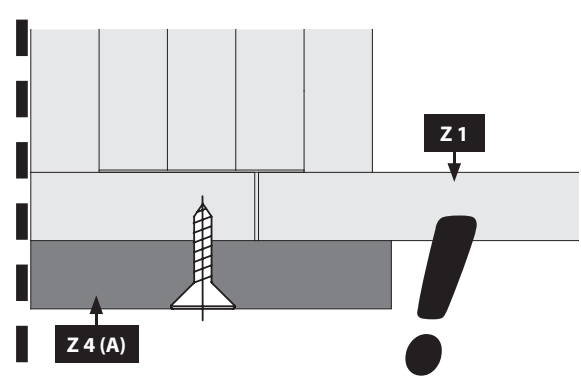

08.2

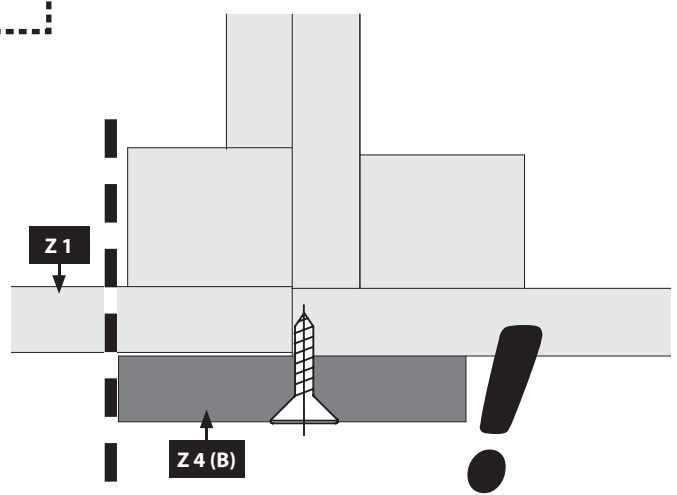



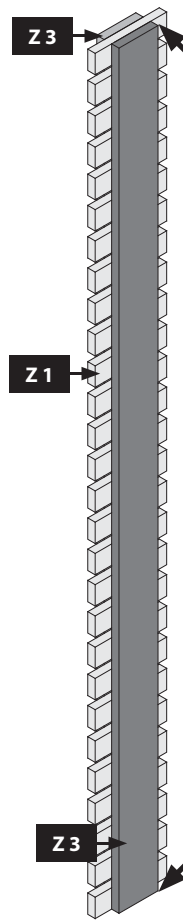
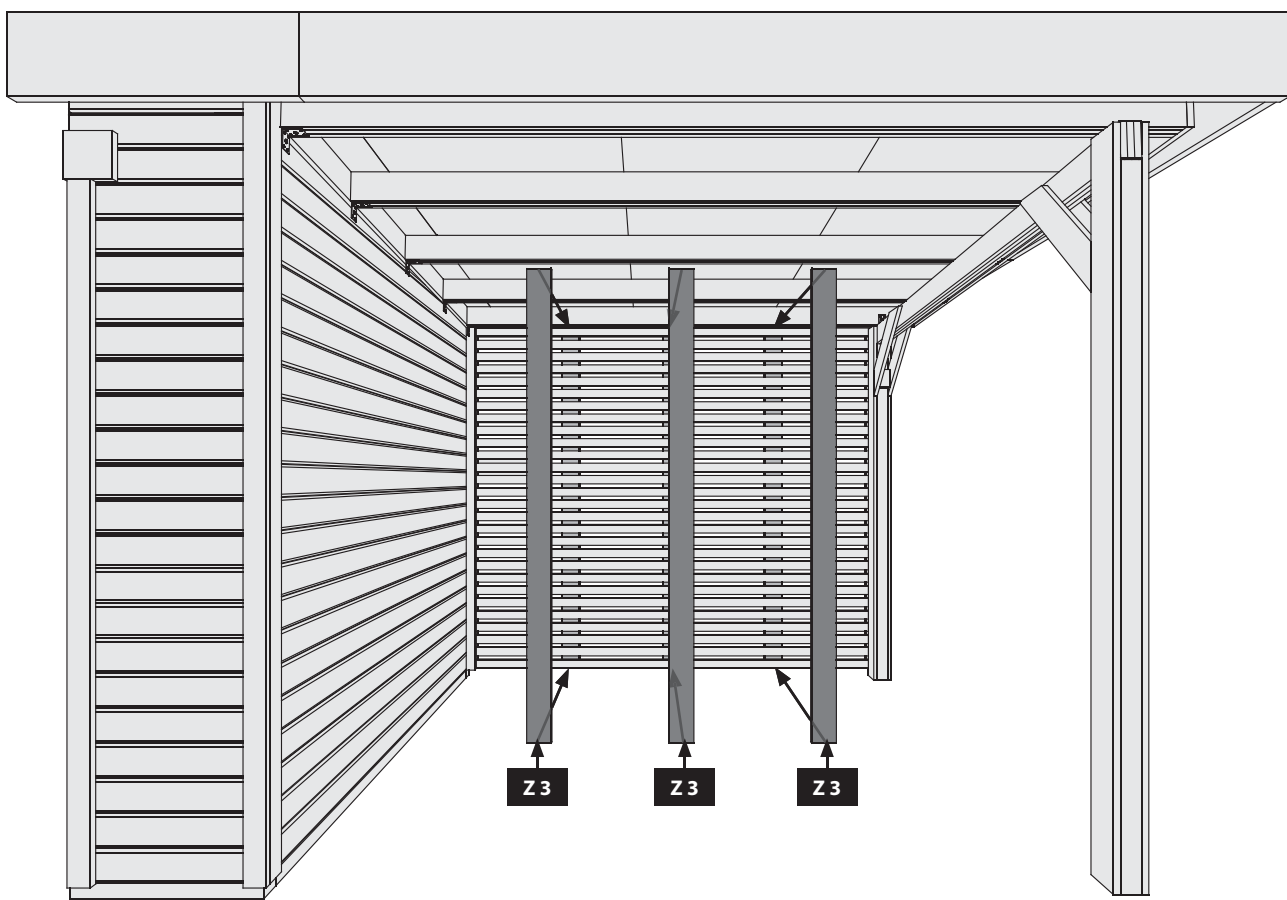
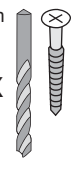

-  Bündig!
-  Flush!
-  Affleurement!
-  Gelijk!
-  I flugt!
-  Aras!
-  Combacia!
-  Stejný !

