

Nevis
Art. Nr. 445193
1/9



13.11.2017

Art. Nr. 445193

Groundplan - Grundplan - Plan demasse -
 Planimetria - Plattegrond - Põhiplaan

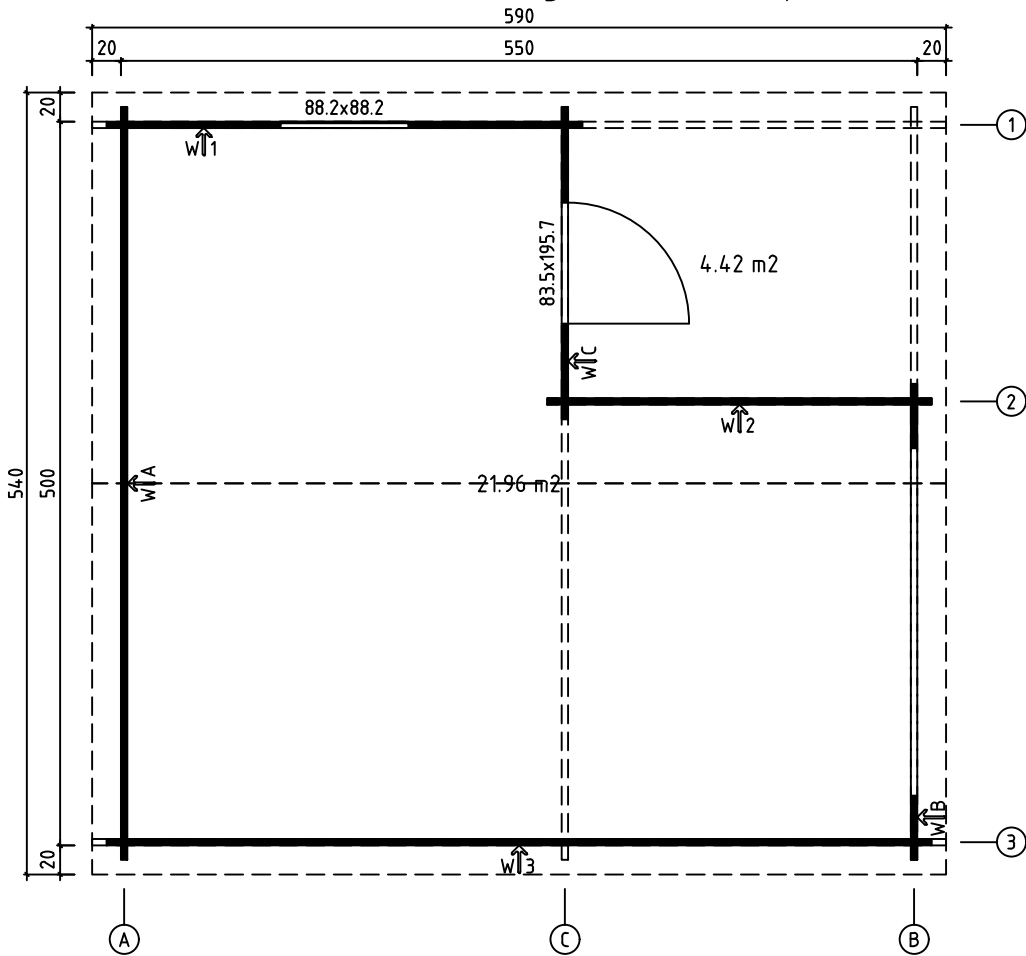

Foundation - Fundament - Fondation -
 Fondamenta - Fundering - Immutatud alusraam

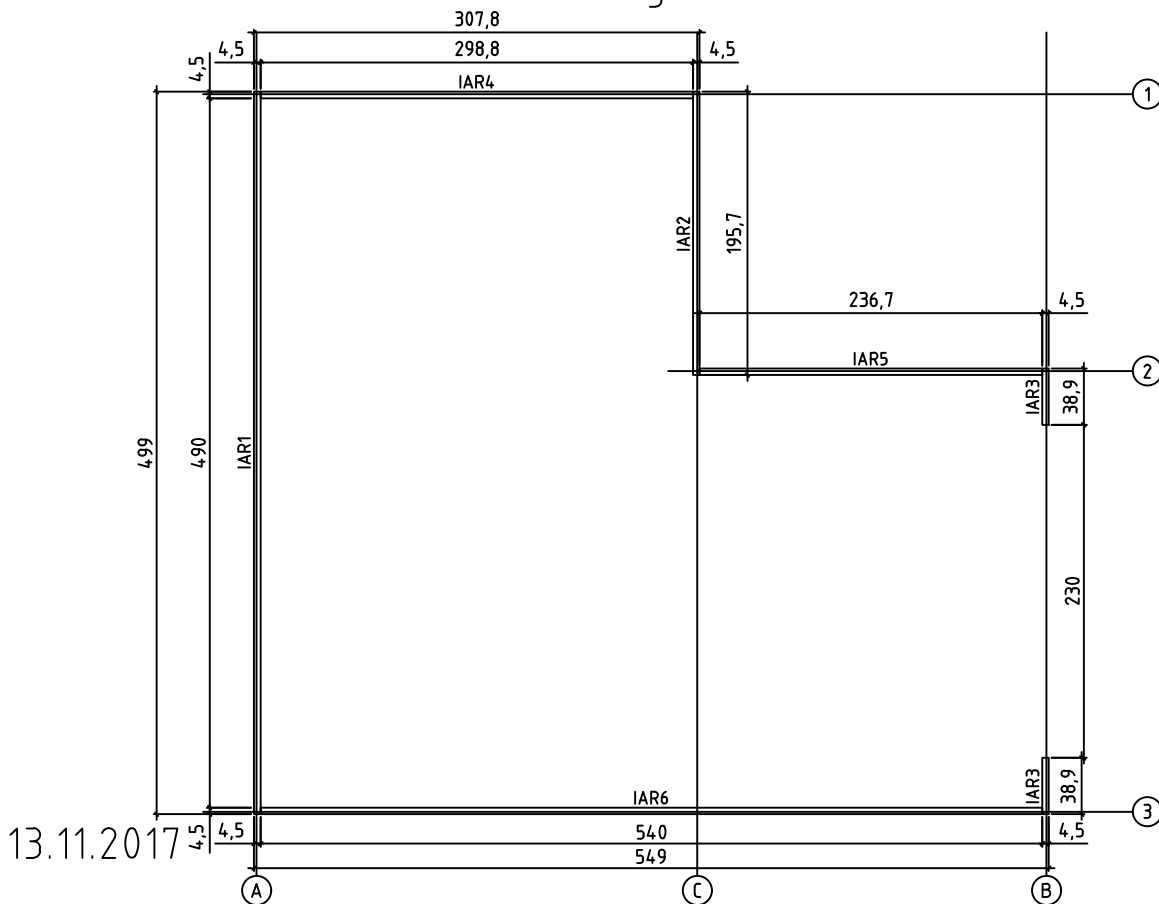



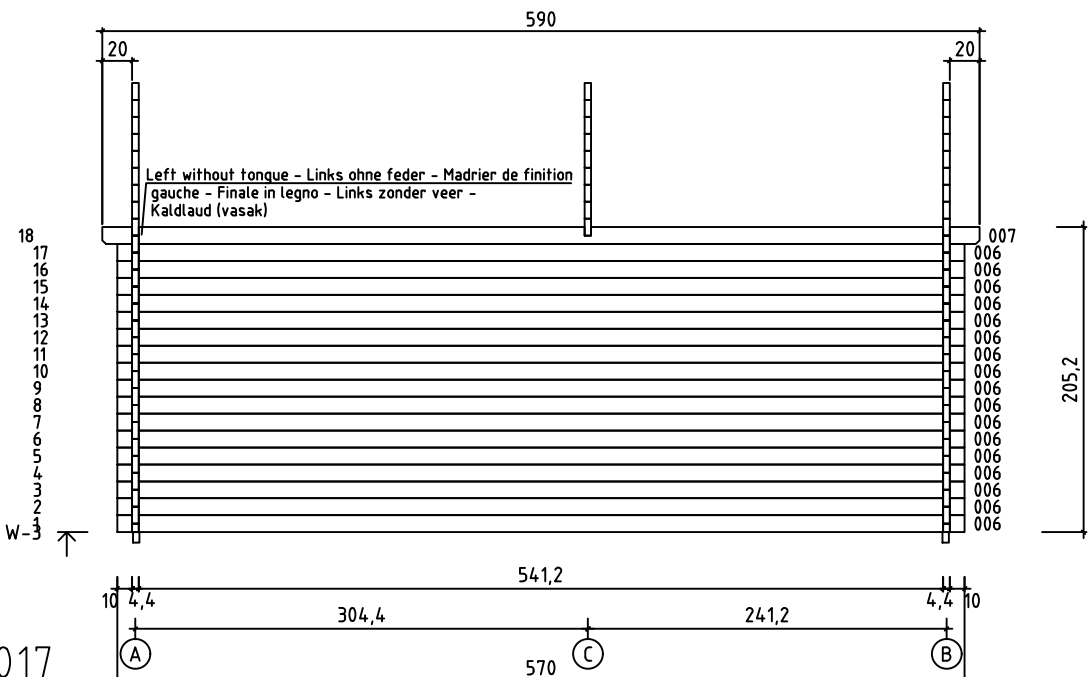
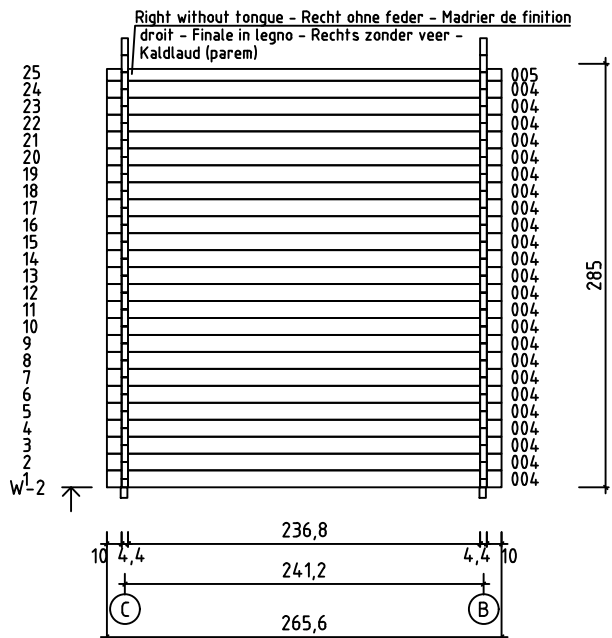
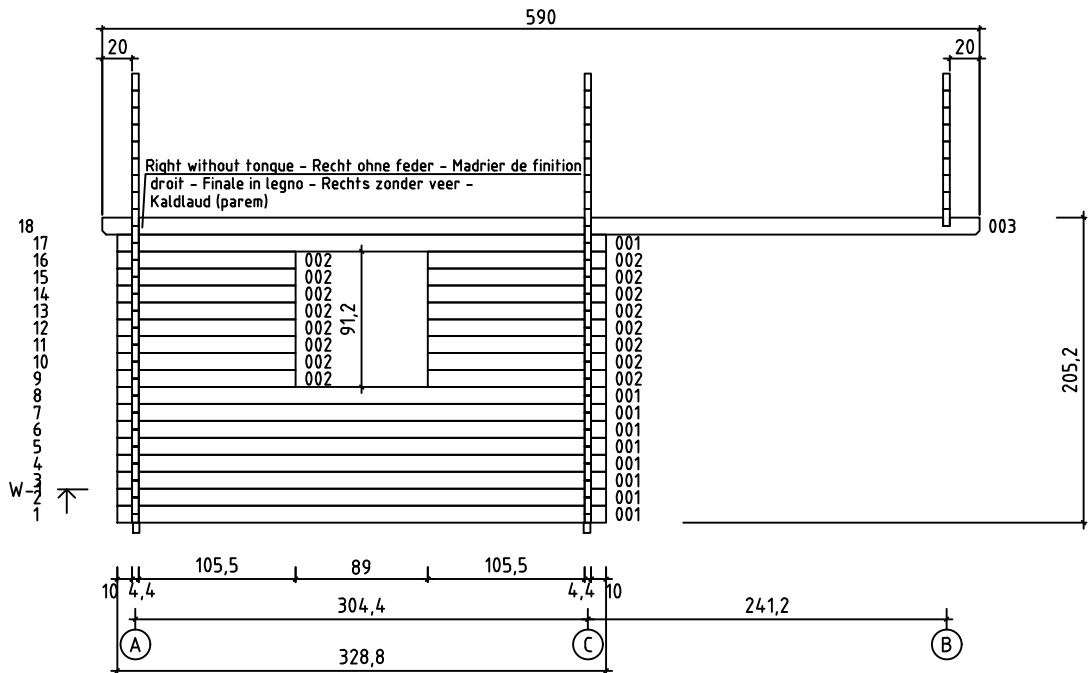



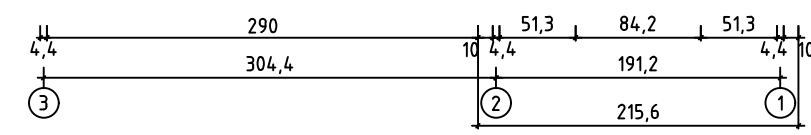
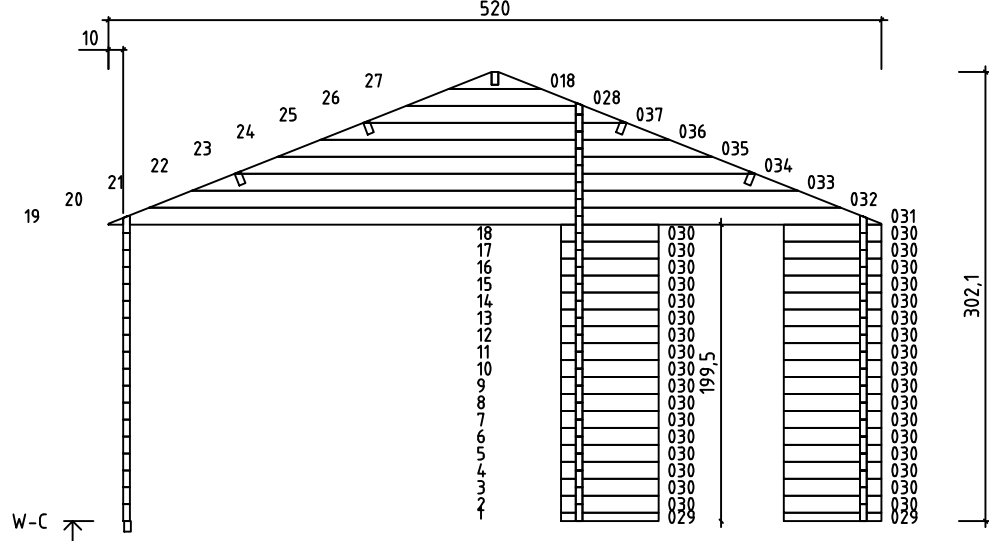
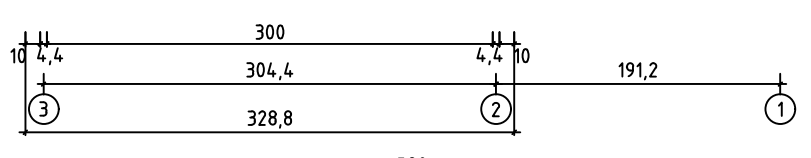
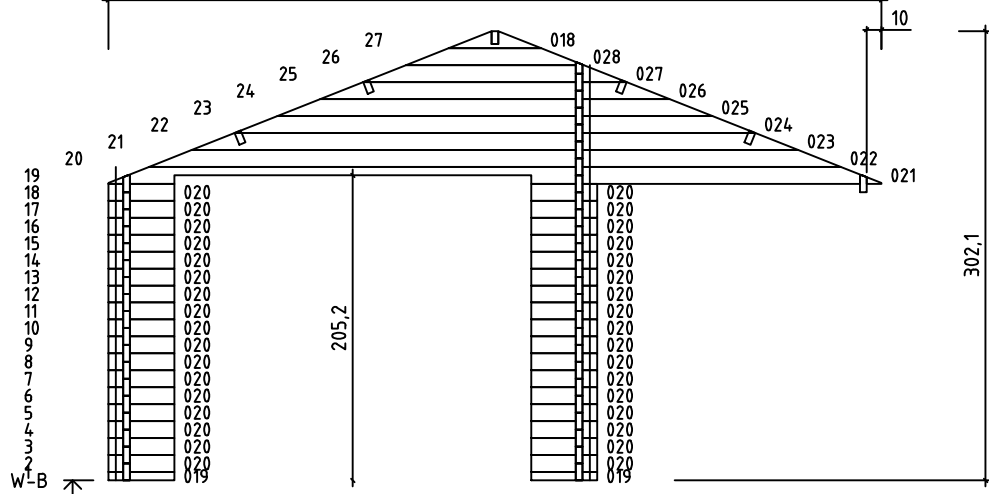
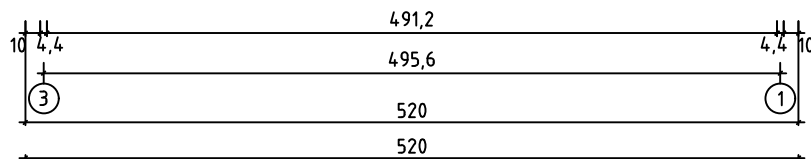
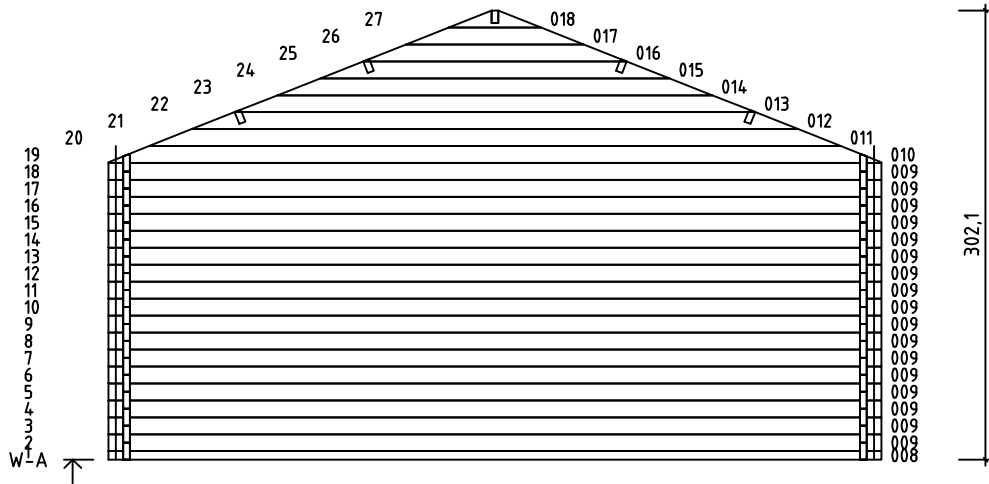

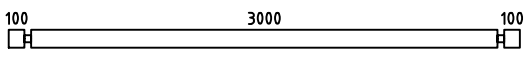
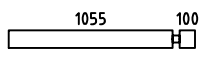
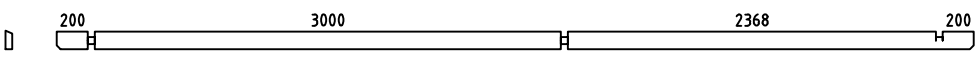
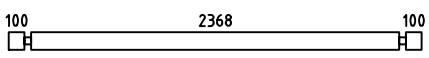
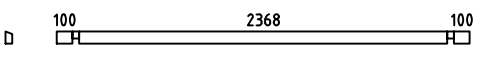
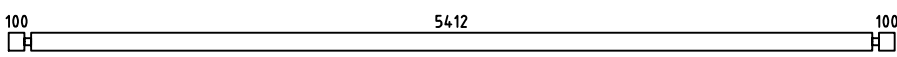
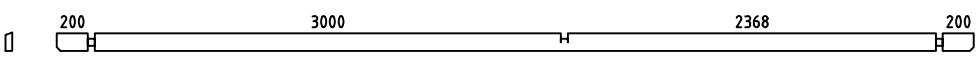
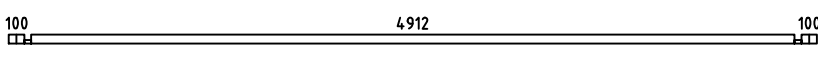
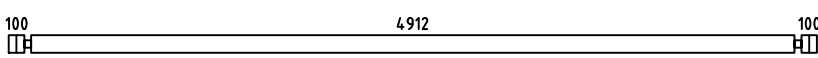

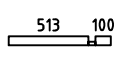
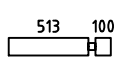
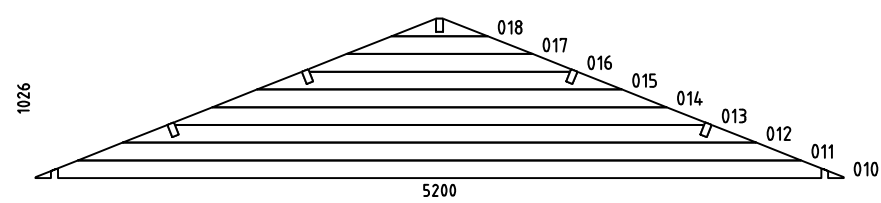
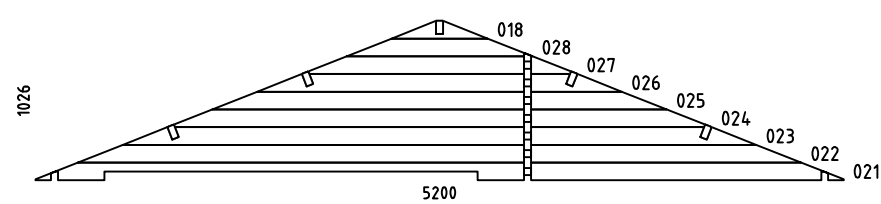
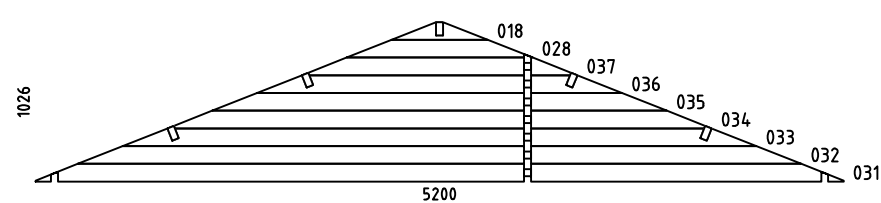
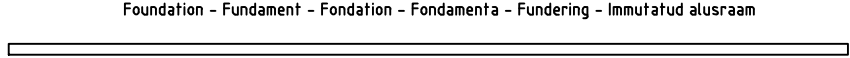

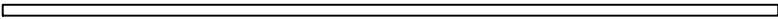
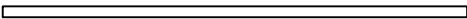
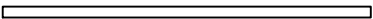
Art. Nr. 445193

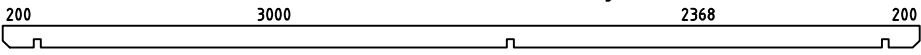

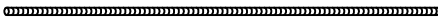

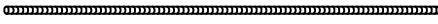
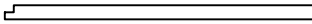
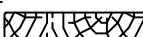

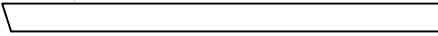
Art. Nr. 445193

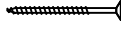
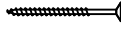
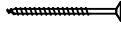
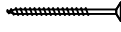
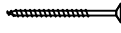
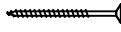
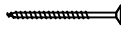

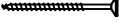
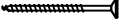
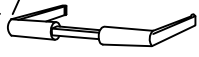
Pos	13.11.2017 Piece list - Stückliste - Liste des pièces - Elementi - Stuklijst - Tükítabel Art. Nr. 445193	5/9	Q	P (mm)	L (mm)
001			9	44x114	3288
002			16	44x114	1199
003			1	44x120	5900
004			24	44x114	2656
005			1	44x78	2656
006			17	44x114	5700
007			1	44x120	5900
008			1	44x57	5200
009			17	44x114	5200
019			2	44x57	444
020			34	44x114	444
029			2	44x57	657
030			34	44x114	657
WA-1			1		
WB-1			1		
WC-1			1		
IAR6		Foundation - Fundament - Fondation - Fondamenta - Fundering - Immutatud alusraam	1	45x70	5400

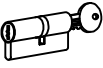
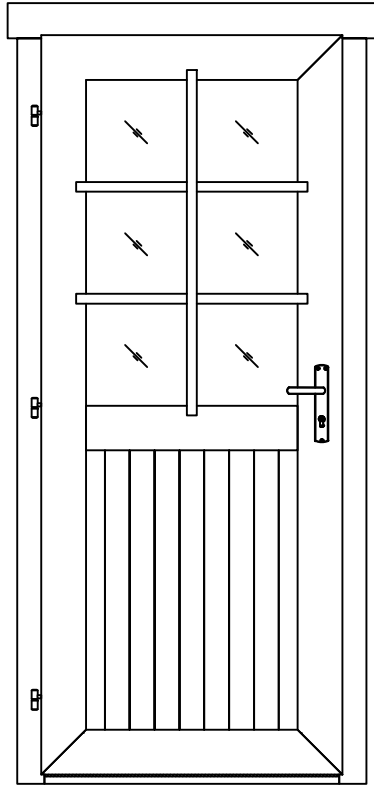
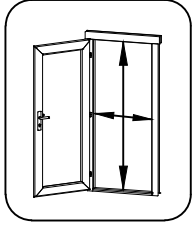
Pos	13.11.2017 Piece list - Stückliste - Liste des pièces - Elementi - Stuklijst - Tükitalabel Art. Nr. 445193 6/9	Q	P (mm)	L (mm)
IAR1	Foundation - Fundament - Fondation - Fondamenta - Fundering - Immutatud alusraam 	1	45x70	4990
IAR4	Foundation - Fundament - Fondation - Fondamenta - Fundering - Immutatud alusraam 	1	45x70	2988
IAR5	Foundation - Fundament - Fondation - Fondamenta - Fundering - Immutatud alusraam 	1	45x70	2367
IAR2	Foundation - Fundament - Fondation - Fondamenta - Fundering - Immutatud alusraam 	1	45x70	1957
IAR3	Foundation - Fundament - Fondation - Fondamenta - Fundering - Immutatud alusraam 	2	45x70	389
PR21	Roof beam - Dachbalken - Panne de toit - Perlina del tetto - Gordingen / dakbalk - Pärilin 	5	44x140	5900
	Roof boards - Dachbretter - Voliges - Perlina per tetto - Dakhout - Katuselaud 	132	90x18	2900
	Roofing felt fillet - Dachpappenleiste - Baguette de fixation du feutre bitumeux - Asse per fissaggio guaina bituminosa - Afdeklijst asfaltpapier - Katusepapiiliist 	4	18x58	2950
	Treaded rod m10 - Gewindestange m10 - Tige fileté m10 - Barra filettata passo m10 - Draadstang 10m - Keermelatt 	3		50
	Treaded rod m10 - Gewindestange m10 - Tige fileté m10 - Barra filettata passo m10 - Draadstang 10m - Keermelatt 	1		800
	Treaded rod m10 - Gewindestange m10 - Tige fileté m10 - Barra filettata passo m10 - Draadstang 10m - Keermelatt 	4		2000
	Post - Pfosten - Poteau - Piede registrabile - Stijl - Post 	1	90x90	1985
TB-1	Fascia board - Traufbrett - Bandeau de toit - Finitura lati tetto - Gevellijst - Räästalaud 	4	18x90	2950
DRV-1	Roof edge reinforcement - Dachrandverstärkung - Corniere de renfort de bord de toit - Rinforzo x tetto - Dakrand versterking - Räästatugevdus 	4	28x34	2950
	Gable moulding - Giebelleiste - Planche de rive - Finitura per frontale e retro del tetto - Gevellijst - Viilulaud 	4	18x120	2950
	Lengthening bolt for treaded rod - Verlängerungsmutter für gewindestange - Manchon de raccordement de tige fileté - Bullone per barra filettata passo - Extensie moer voor draadstang - Keermelati jätkumutter 	4	D10	
HS8	Screw for gable segment - Schrauben für deckblatt - Vis pour fixation losange de finition - Viti x frontali tetto - Schroef voor gevelpunt segment - Krugi rombile 	4	3.5x35	
HS9	Screw for gable moulding - Schrauben für giebelleiste - Vis pour fixation planche de rive - Vite per fissare finiture davanti e dietro del tetto - Schroef voor gevellijst - Krugi viilulauale 	32	3.5x50	
HS14	Screw for post - Schrauben für pfosten - Vis de fixation des poteaux - Viti per inviare - Schroef voor stijlen - Krugi postile 	2	4.5x80	
HS12	Screw for fascia boards - Schrauben für traufbretter - Vis pour fixation bandeau de toit - Viti x striscia del tetto - Schroef voor gevellijst - Krugi räästalauale 	28	4x40	
HS12	Screw for roof edge reinforcement - Schrauben für dachrandverstärkung - Vis pour fixation corniere renfort de bord de toit - Viti x rinforzo bordo tetto - Schroef voor dakrand versterking - Krugi räästatugevdusele 	28	4x40	
HS18	Screw for roof beams - Schrauben für dachbalken - Vis pour fixation pannes de toit - Viti per perline del tetto - Schroef voor gordingen / dakbalken - Krugi pärlinitele 	21	5x120	
HS18	Screw for gable - Schrauben für giebel - Vis pour fixation des pignons - Viti per timpano - Schroef voor gevelpunt - Krugi viilude kinnitamiseks 	54	5x120	

Pos	13.11.2017 Piece list - Stückliste - Liste des pièces - Elementi - Stuklijst - Tükitalabel 835x1957 UK.2.056.TSVV.MM SGC 8/9	Q	P (mm)	L (mm)
HS1	Screw for georgian bars - Schraube für sprossen - Vis pour croisillons - Viti per unire la griglia georgiana della finestra - Schroeven voor raamverdeling - Kruvi ukse petfeliistule 	6	2.5x20	
HS25	Screw for doorstep - Schrauben für swelle - Vis pour fixation barre de seuil - Vite per soglia della porta - Schroef voor deurdorpel - Kruvi lävepakule 	2	4.5x65	
TL4	Door handle fittings - Türgriff - Poignée de porte - Maniglie - Deurhendel klink - Ukse käepide VU 	1		
TL5	Set of door lock covers - Schlossblenden - Set de garnitures de porte - Copertura serrature - Slot sluitplaat set - Ukse lukuplaat 	1		
	Cylinder lock - Zylinderschloss - Barillet de porte - Serratura - Cylinder slot - Ukse lukusüdamik 	1		
<p>Glass size - Glasgröße - Taille de la vitre - Misura del vetro - Glas afmeting - Klaasi mõõt: 561x855 mm</p> <div style="display: flex; justify-content: space-around; align-items: center;">  <div style="text-align: center;">  <p>735x1875 mm</p> </div> </div>				

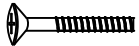
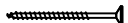
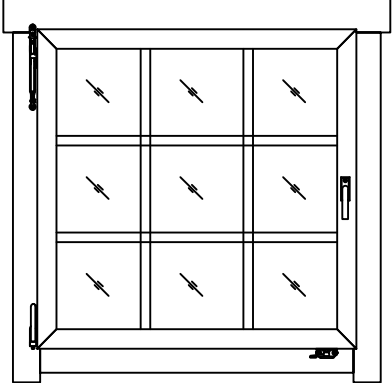
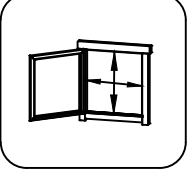
Pos	13.11.2017 Piece list - Stückliste - Liste des pièces - Elementi - Stuklijst - Tükitabel 882x882 AK.1.109.TSSV.b SGC 9/9	Q	P (mm)	L (mm)
FS1	Window handle fittings - Fenstergriff - Poignée de fenetre - Maniglia c/ferramenta - Raamhendel -/grendel -/klink - Aknalink 	1		
FSP	Bolt for window handle fittings - Bolzen für fenstergriff beschlag - Vis pour fixation poignée de fenetre - Bullone x apertura manuale finestra - Schroef voor raamhendel - Akna käepideme polt 	2		
HS1	Screw for georgian bars - Schraube für sprossen - Vis pour croisillons - Viti per unire la griglia georgiana della finestra - Schroeven voor raamverdeling - Krugi akna petteliistule 	8	2.5x20	
<p data-bbox="258 421 1284 452">Glass size - Glasgröße - Taille de la vitre - Misura del vetro - Glas afmeting - Klaasi mõõt: 738x738 mm</p>   <p data-bbox="1369 622 1497 654">782x782 mm</p>				