

Lieber Kunde,

wir beglückwünschen Sie zum Kauf dieser Leuchte. Sie haben damit ein Produkt erworben, welches nach dem heutigen Stand der Technik hergestellt wurde.

Damit Sie von Anfang an und solange wie möglich Freude daran haben, lesen Sie bitte sorgfältig vor Inbetriebnahme alle Montage-, Pflege- und Sicherheitshinweise sowie evtl. beiliegende Informationsbroschüren zu besonderen Produkteigenschaften.

Dear Customer,

Congratulations on purchasing this product. You've chosen a product which is built to the highest levels of technical possibilities.

To fully enjoy your new lamp and to maximise it's efficiency, please read and store all installation, care and safety instructions and any other attached information brochures detailing special product features.

Cher Client, Chère cliente,

Nous vous félicitons pour l'achat de ce produit. Vous avez choisi un produit construit avec les techniques les plus sophistiquées.

Pour apprécier votre nouveau produit et pour vous assurer de son efficacité, nous vous remercions de bien vouloir lire toutes les informations de montage, de sécurité et les renseignements notés dans les caractéristiques du produit.

-DE- Montageanleitung	-LT- Montavimo instrukcija	-HU- Szerelési útmutató	-GR- Οδηγίες τοποθέτησης
-IT- Istruzioni per il montaggio	-LV- Montāžas instrukcija	-RO- Instrucțiuni de montaj	-DK- Montagevejledning
-FR- Instructions de montage	-EE- Paigaldusjuhend	-SI- Navodila za montažo	-FI- Asennusopas
-GB- Installation Instructions	-PL- instrukcja montażu	-HR- Upute za uporabu	-SE- montageinstruktion
-ES- Instrucciones de montaje	-CZ- Návod k montáži	-RS- Uputstva za upotrebu	-NO- Monteringsanvisning
-NL- Montagehandleiding	-SK- Montážny návod	-RU- Руководство по монтажу	-IS- samsetningarleiðbeiningar
-PT- Instruções de montagem	-BG- Инструкция за монтаж	-TR- Montaj Talimatı	

Artikel/Serie Nr.: 95550106x000

Montage der Beleuchtungseinrichtung

Bitte schalten Sie die Stromversorgung aus Sicherheitsgründen während der Montage aus.

Rückseite des Lampenkörpers

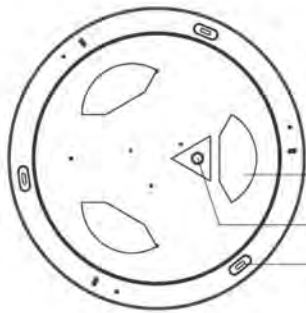

Schwammartiger hinterer Kleber

Festes Montageloch

Befestigungsloch

Lampenkörper

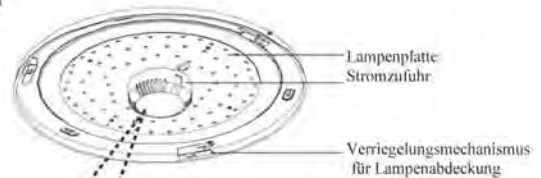

Lampenplatte
Stromzufuhr

Verriegelungsmechanismus
für Lampenabdeckung

- ① Loch für Stromleitung
- ② Stromschnittstelle
- ③ Signalempfänger für die Fernbedienung

Verzerrtes Bild

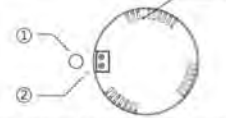

Abmessungen (mm)

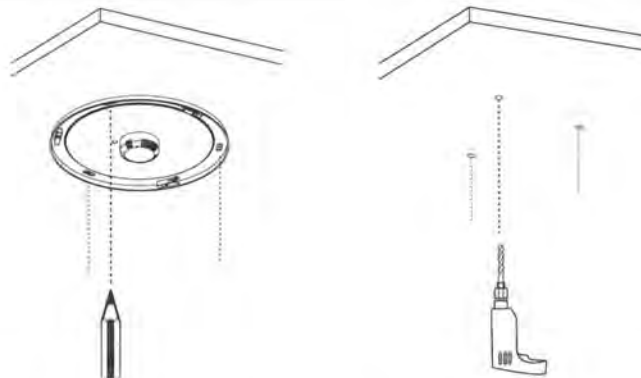
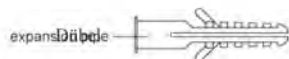
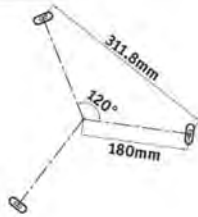

Sollte die Decke aus Stahlbeton sein, bohren Sie vor Montage der Lampe ein Loch in die Decke und setzen Sie einen Dübel ein. (Sollte die Decke aus Holz sein, können Sie die Lampe direkt mit Schrauben ohne Dübel montieren.)

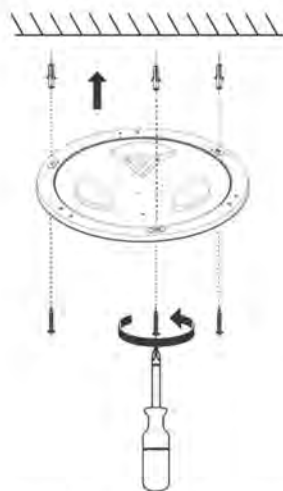

Bestätigen

Bitte montieren Sie im folgenden Fall die Lampe neu:
Der Lampenkörper wackelt von einer Seite zur anderen, und es ist ein Knirschen zu hören.

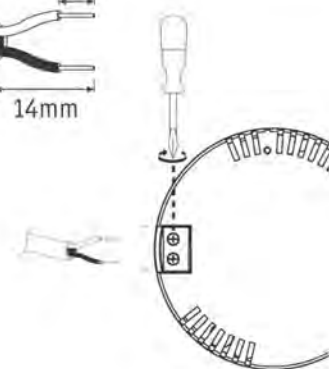
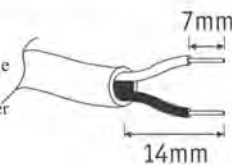
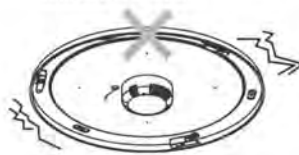

- ① Führen Sie das Stromkabel in der Decke durch das Loch in der Grundplatte.
- ② Befestigen Sie die Grundplatte mit 3 Schrauben an der Decke.

Führen Sie den stromführenden Leiter sowie den Neutralleiter der Stromversorgung jeweils in die mit L und N gekennzeichneten Anschlussklemmen, ziehen Sie diese mit dem Schraubendreher fest.

-DE- Montageanleitung	-LT- Montavimo instrukcija	-HU- Szerelési útmutató	-GR- Οδηγίες τοποθέτησης
-IT- Istruzioni per il montaggio	-LV- Montāžas Instrukcija	-RO- Instrucțiuni de montaj	-DK- Montagevejledning
-FR- Instructions de montage	-EE- Paigaldusjuhend	-SI- Navodila za montažo	-FI- Asennusopas
-GB- Installation Instructions	-PL- Instrukcja montażu	-HR- Upute za uporabu	-SE- montageinstruktion
-ES- Instrucciones de montaje	-CZ- Návod k montáži	-RS- Uputstva za upotrebu	-NO- Monteringsanvisning
-NL- Montagehandleiding	-SK- Montážny návod	-RU- Руководство по монтажу	-IS- samsetningarleiðbeiningar
-PT- Instruções de montagem	-BG- Инструкция за монтаж	-TR- Montaj Talimatı	

Artikel/Serie Nr.: 95550106x000

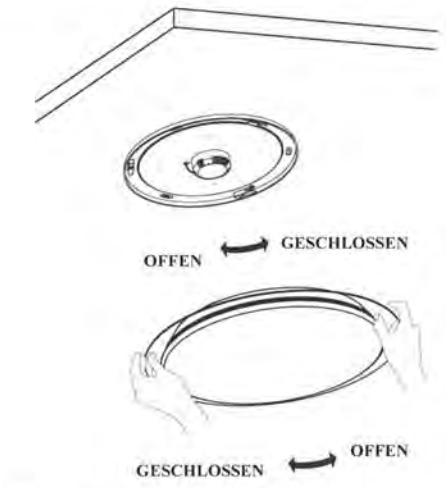

Bringen Sie die Lampenabdeckung an und drehen Sie diese zum Befestigen im Uhrzeigersinn.



Achtung

Stellen Sie sicher, dass Lampenabdeckung und Lampenkörper richtig befestigt sind, da die Lampenabdeckung andernfalls herunterfallen kann.

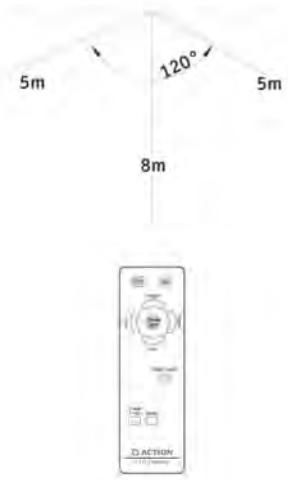
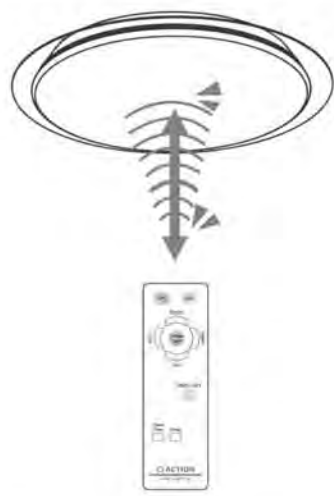

Betrieb des Wandschalters

EIN / AUS

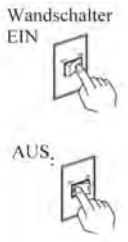

Beleuchtungsstand beim letzten Ausschalten der Lampe (Helligkeit und Farbtemperatur)

Ausschalten und Speichern der aktuellen Helligkeit und Farbtemperatur

Schalten des Beleuchtungsstands

Schalten Sie den Schalter zum Einschalten des Lichts schnell ein und aus (innerhalb von 2 Sekunden)

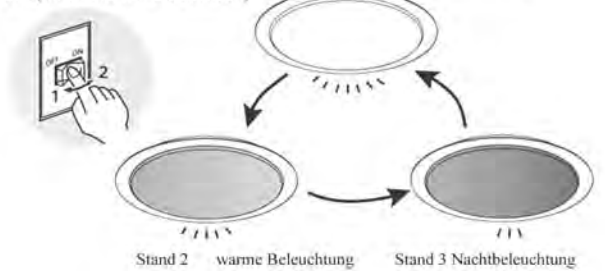

-DE- Montageanleitung	-LT- Montavimo instrukcija	-HU- Szerelési útmutató	-GR- Οδηγίες τοποθέτησης
-IT- Istruzioni per il montaggio	-LV- Montāžas instrukcija	-RO- Instrucțiuni de montaj	-DK- Montagevejledning
-FR- Instructions de montage	-EE- Paigaldusjuhend	-SI- Navodila za montažo	-FI- Asennusopas
-GB- Installation Instructions	-PL- instrukcja montażu	-HR- Upute za uporabu	-SE- montageinstruktion
-ES- Instrucciones de montaje	-CZ- Návod k montáži	-RS- Uputstva za upotrebu	-NO- Monteringsanvisning
-NL- Montagehandleiding	-SK- Montážny návod	-RU- Руководство по монтажу	-IS- samsetningarleiðbeiningar
-PT- Instruções de montagem	-BG- Инструкция за монтаж	-TR- Montaj Talimatı	

Artikel/Serie Nr.: 95550106x000

Betrieb der Fernbedienung

Stellen Sie den Wandschalter auf "EIN".

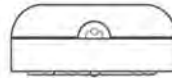

Signalsender
Dieser darf nicht zerkratzt oder verschmutzt sein.

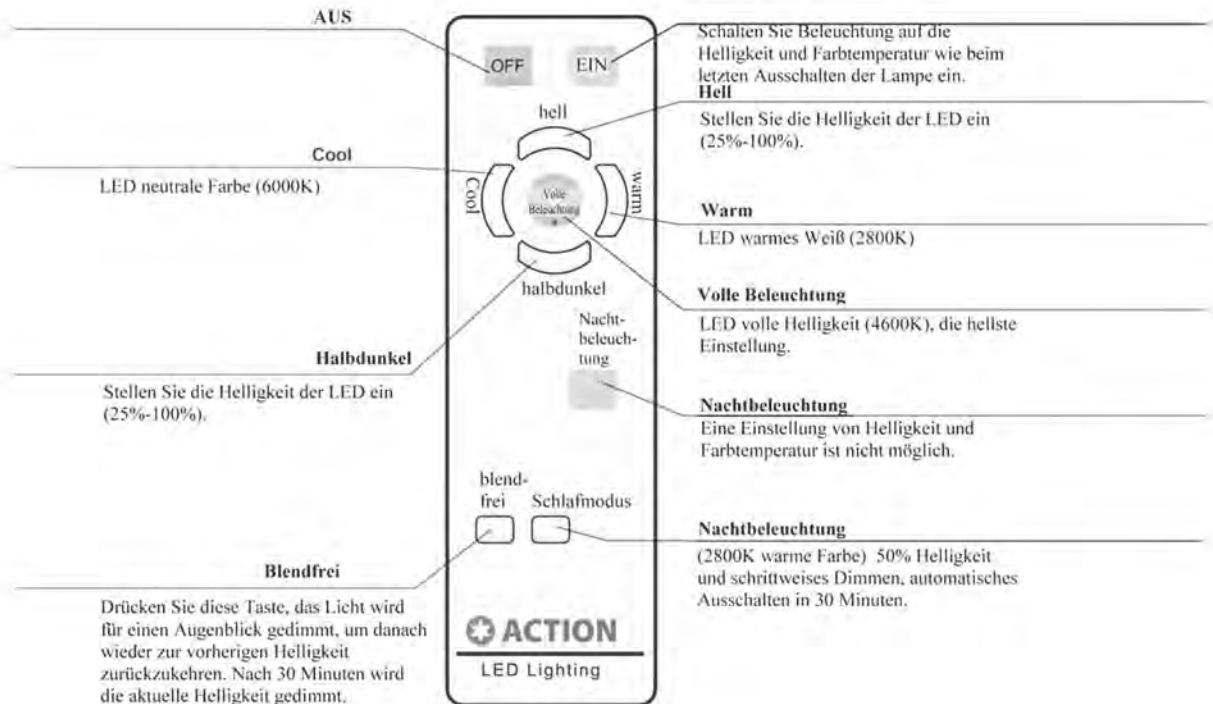

Hinweis:
Bitte stellen Sie bei Verwendung der Fernbedienung sicher, dass der Wandschalter eingeschaltet ist, andernfalls ist eine Steuerung über die Fernbedienung nicht möglich.



Standardbatterie
Bitte legen Sie die Batterie richtig ein und wechseln Sie diese korrekt. Beachten Sie hierbei + und -Pol.

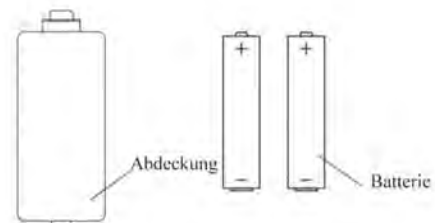

Batteriespezifikation: 7. Batterie R03(AAA) 1,5V 2 Stück

-DE- Montageanleitung	-LT- Montavimo instrukcija	-HU- Szerelési útmutató	-GR- Οδηγίες τοποθέτησης
-IT- Istruzioni per il montaggio	-LV- Montāžas instrukcija	-RO- Instrucțiuni de montaj	-DK- Montagevejledning
-FR- Instructions de montage	-EE- Paigaldusjuhend	-SI- Navodila za montažo	-FI- Asennusopas
-GB- Installation Instructions	-PL- instrukcja montażu	-HR- Upute za uporabu	-SE- montageinstruktion
-ES- Instrucciones de montaje	-CZ- Návod k montáži	-RS- Uputstva za upotrebu	-NO- Monteringsanvisning
-NL- Montagehandleiding	-SK- Montážny návod	-RU- Руководство по монтажу	-IS- samsetningarleiðbeiningar
-PT- Instruções de montagem	-BG- Инструкция за монтаж	-TR- Montaj Talimatı	

Artikel/Serie Nr.: 95550106x000

Installation of Lighting Device

For safety, please cut off the power during installation.

backside of the lamp body

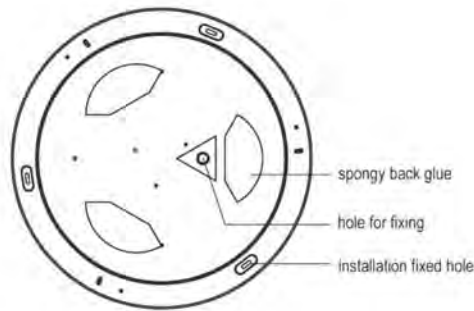

lamp body

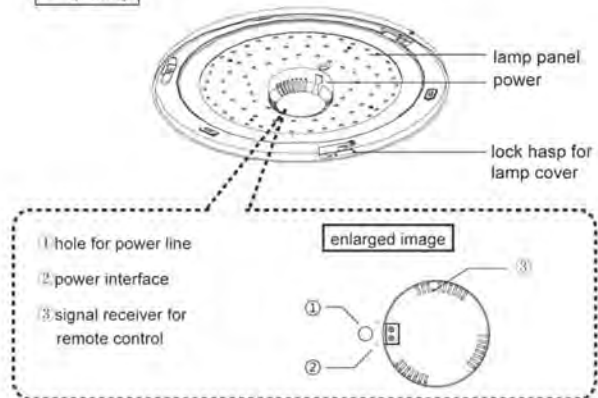

space dimension (mm)

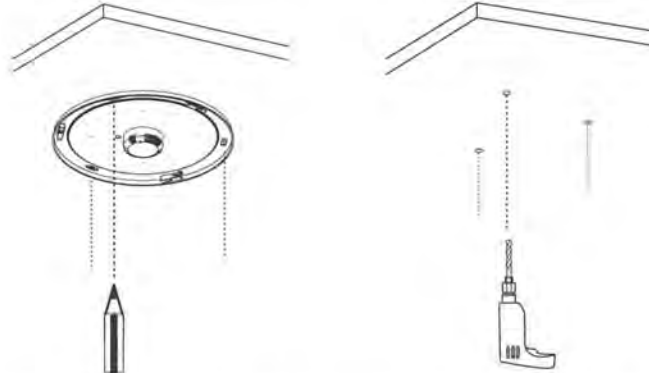
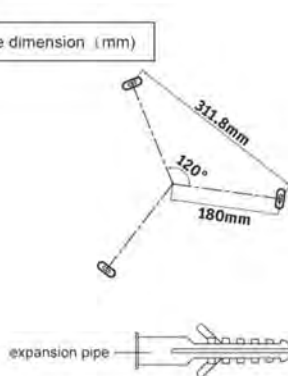

If the ceiling is of reinforced concrete structure, please punch and install an expansion pipe before installing the lamp. (If the ceiling is wooden, install the lamp directly with screws, no need for the expansion pipe.)

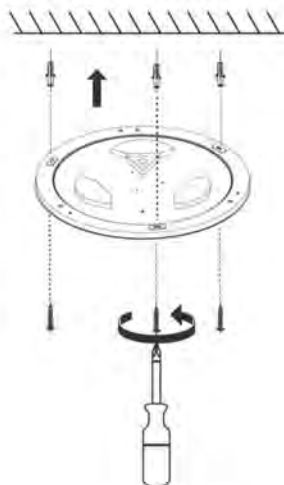

Confirm

Please reinstall the lamp in the following case:
The lamp body wags from side to side and makes a crunching sound.

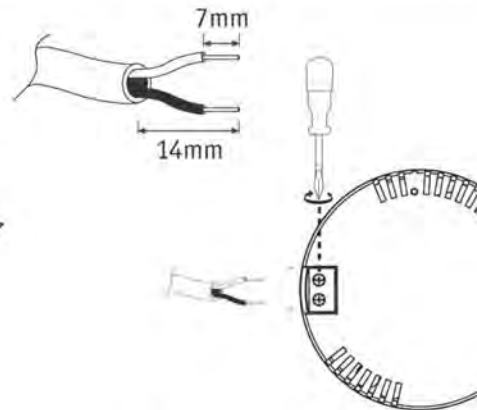
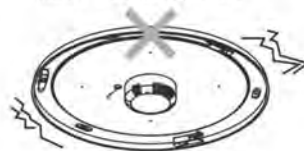

Insert live wire and neutral wire of the power respectively into connection terminals marked with L and N, fix them tightly with a screwdriver.

- 1 Pass the power line on the ceiling through the hole on base plate.
- 2 Fix the base plate to the ceiling by 3 screws.

-DE- Montageanleitung	-LT- Montavimo instrukcija	-HU- Szerelési útmutató	-GR- Οδηγίες τοποθέτησης
-IT- Istruzioni per il montaggio	-LV- Montāžas instrukcija	-RO- Instrucțiuni de montaj	-DK- Montagevejledning
-FR- Instructions de montage	-EE- Paigaldusjuhend	-SI- Navodila za montažo	-FI- Asennusopas
-GB- Installation Instructions	-PL- Instrukcja montażu	-HR- Upute za uporabu	-SE- montageinstruktion
-ES- Instrucciones de montaje	-CZ- Návod k montáži	-RS- Uputstva za upotrebu	-NO- Monteringsanvisning
-NL- Montagehandleiding	-SK- Montážny návod	-RU- Руководство по монтажу	-IS- samsetningarleiðbeiningar
-PT- Instruções de montagem	-BG- Инструкция за монтаж	-TR- Montaj Talimatı	

Artikel/Serie Nr.: 95550106x000

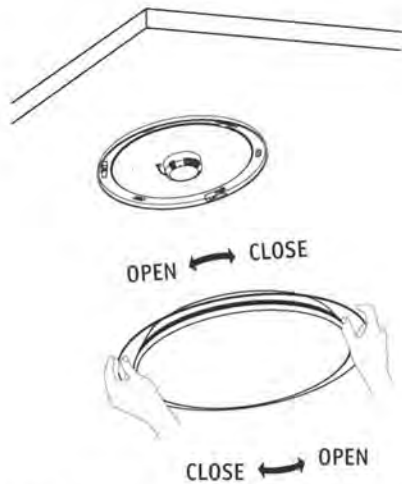

Put on the lamp cover and rotate it clockwise to fix.



Attention

Please make sure the lamp cover and lamp body is fully integrated, otherwise lamp cover may fall down.

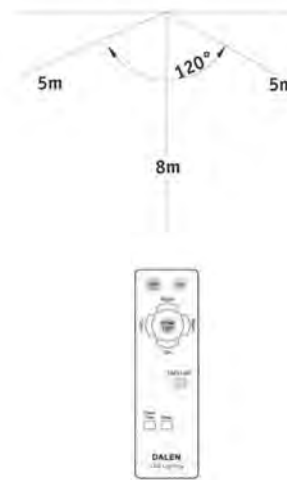
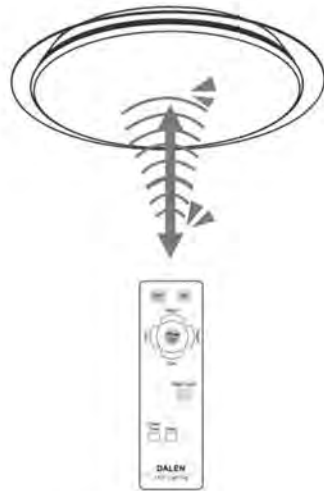

Wall Switch Operation

ON / OFF

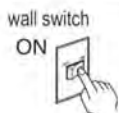

light state of last time turned off (brightness and color temperature)



turn off and remember current brightness and color temperature

switch light state

Switch on and off quickly when turning on the light. (within 2 seconds)



State1 whole light

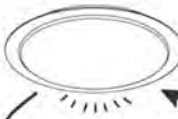

State2 warm light



State3 night light

-DE- Montageanleitung	-LT- Montavimo instrukcija	-HU- Szerelési útmutató	-GR- Οδηγίες τοποθέτησης
-IT- Istruzioni per il montaggio	-LV- Montāžas instrukcija	-RO- Instrucțiuni de montaj	-DK- Montagevejledning
-FR- Instructions de montage	-EE- Paigaldusjuhend	-SI- Navodila za montažo	-FI- Asennusopas
-GB- Installation instructions	-PL- Instrukcja montażu	-HR- Upute za uporabu	-SE- montageinstruktion
-ES- Instrucciones de montaje	-CZ- Návod k montáži	-RS- Uputstva za upotrebu	-NO- Monteringsanvisning
-NL- Montagehandleiding	-SK- Montážny návod	-RU- Руководство по монтажу	-IS- samsetningarleiðbeiningar
-PT- Instruções de montagem	-BG- Инструкция за монтаж	-TR- Montaj Talimatı	

Artikel/Serie Nr.: 95550106x000

Remote Control Operation

Set the wall switch "ON".

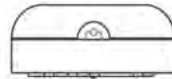

signal sender
*Please do not scratch or dirty.

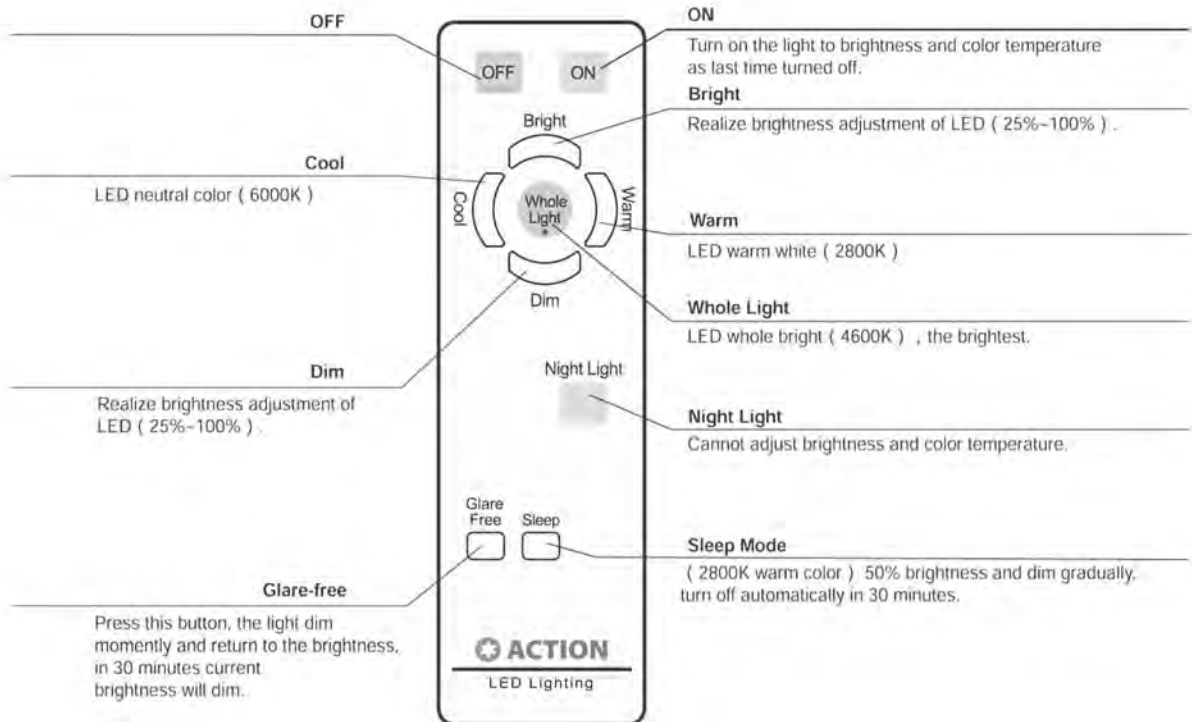

Note:
When using remote control, please confirm the wall switch is on, otherwise remote control cannot be realized.

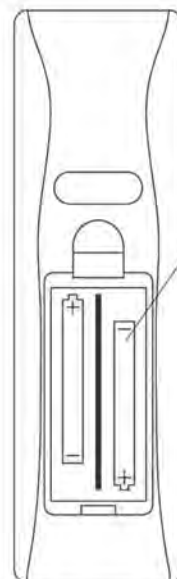

standard battery

Please install and change battery correctly according to anode and cathode.

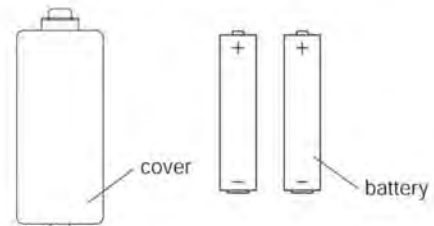

battery specification: 7th battery R03(AAA) 1.5V 2pcs

-DE- Montageanleitung	-LT- Montavimo instrukcija	-HU- Szerelési útmutató	-GR- Οδηγίες τοποθέτησης
-IT- Istruzioni per il montaggio	-LV- Montāžas instrukcija	-RO- Instrucțiuni de montaj	-DK- Montagevejledning
-FR- Instructions de montage	-EE- Paigaldusjuhend	-SI- Navodila za montažo	-FI- Asennusopas
-GB- Installation instructions	-PL- Instrukcja montażu	-HR- Upute za uporabu	-SE- montageinstruktion
-ES- Instrucciones de montaje	-CZ- Návod k montáži	-RS- Uputstva za upotrebu	-NO- Monteringsanvisning
-NL- Montagehandleiding	-SK- Montážny návod	-RU- Руководство по монтажу	-IS- samsetningarleiðbeiningar
-PT- Instruções de montagem	-BG- Инструкция за монтаж	-TR- Montaj Talimatı	

Artikel/Serie Nr.: 95550106x000

Montage du dispositif d'éclairage

Pour des raisons de sécurité, veuillez couper l'alimentation électrique pendant le montage.

Arrière du corps de lampe

Corps de lampe

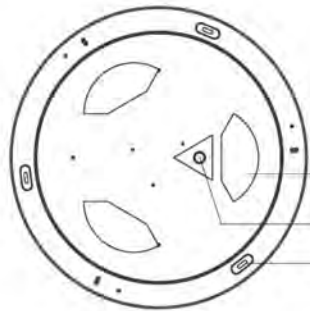

Adhésif spongieux à l'arrière
Trous de fixation
Trous de montage fixe

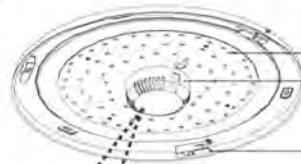

Support de lampe
Alimentation électrique

Mécanisme de verrouillage du diffuseur

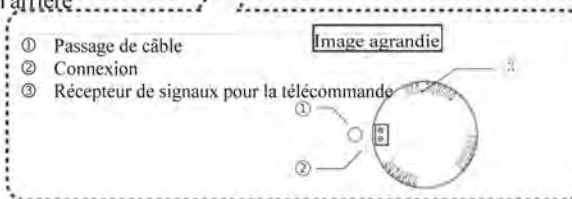
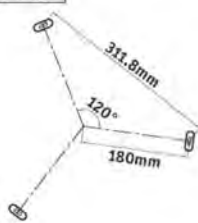

Image agrandie

- ① Passage de câble
- ② Connexion
- ③ Récepteur de signaux pour la télécommande

Dimensions (mm)



Cheville

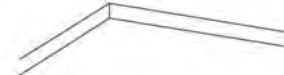
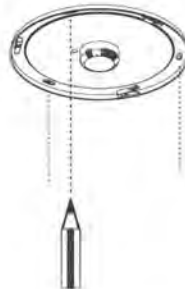
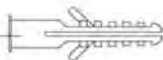

Si le plafond est en béton armé, percez-y un trou avant le montage de la lampe et insérez une cheville. (Si le plafond est en bois, vous pouvez monter la lampe directement avec des vis, sans cheville.)

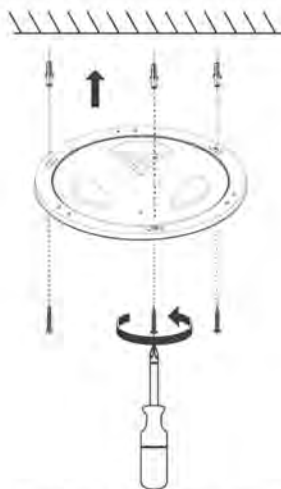

Confirmer

Dans le cas suivant, veuillez recommencer le montage de la lampe :
Le corps de lampe peut être remué d'un côté et de l'autre et un grincement est audible.

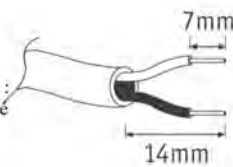
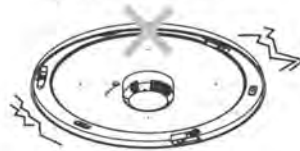

- ① Faites passer le câble du plafond par le trou de la plaque de support
- ② Fixez la plaque de support au plafond avec 3 vis.

Placez le fil conducteur ainsi que le neutre de l'alimentation respectivement dans les bornes repérées par un L et un N, puis serrez-les avec un tournevis.

-DE- Montageanleitung	-LT- Montavimo instrukcija	-HU- Szerelési útmutató	-GR- Οδηγίες τοποθέτησης
-IT- Istruzioni per il montaggio	-LV- Montāžas instrukcija	-RO- Instrucțiuni de montaj	-DK- Montagevejledning
-FR- Instructions de montage	-EE- Paigaldusjuhend	-SI- Navodila za montažo	-FI- Asennusopas
-GB- Installation Instructions	-PL- Instrukcja montażu	-HR- Upute za uporabu	-SE- montageinstruktion
-ES- Instrucciones de montaje	-CZ- Návod k montáži	-RS- Uputstva za upotrebu	-NO- Monteringsanvisning
-NL- Montagehandleiding	-SK- Montážny návod	-RU- Руководство по монтажу	-IS- samsetningarleiðbeiningar
-PT- Instruções de montagem	-BG- Инструкция за монтаж	-TR- Montaj Talimatı	

Artikel/Serie Nr.: 95550106x000

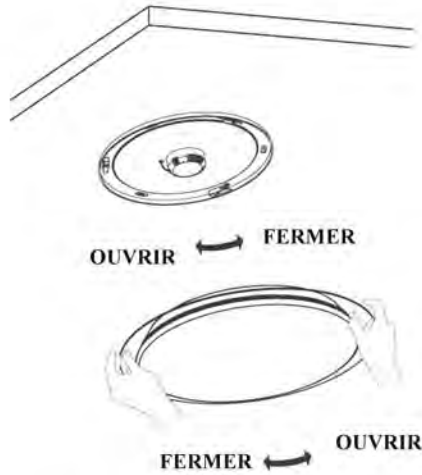

Attention

Installez le diffuseur et tournez-le dans le sens horaire pour le fixer.

Assurez-vous que le diffuseur et le corps de lampe sont correctement fixés. Sinon, le diffuseur peut tomber.

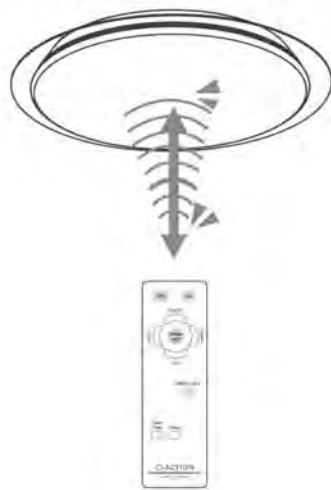

Utilisation de l'interrupteur mural

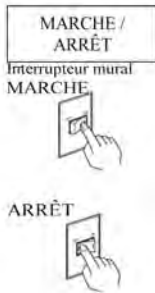

Activation de l'état d'éclairage

Mettez rapidement (en l'espace de 2 secondes) l'interrupteur sur marche et sur arrêt pour allumer la lampe

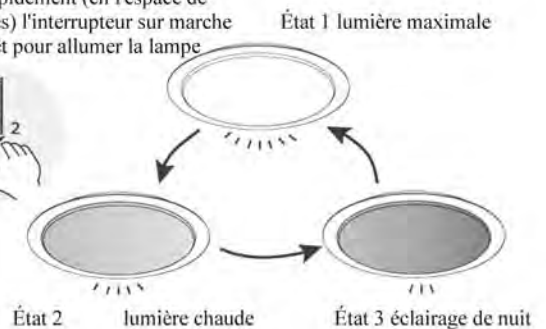

-DE- Montageanleitung	-LT- Montavimo instrukcija	-HU- Szerelési útmutató	-GR- Οδηγίες τοποθέτησης
-IT- Istruzioni per il montaggio	-LV- Montāžas instrukcija	-RO- Instrucțiunile de montaj	-DK- Montagevejledning
-FR- Instructions de montage	-EE- Paigaldusjuhend	-SI- Navodila za montažo	-FI- Asennusopas
-GB- Installation instructions	-PL- Instrukcja montażu	-HR- Upute za uporabu	-SE- montageinstruktion
-ES- Instrucciones de montaje	-CZ- Návod k montáži	-RS- Uputstva za upotrebu	-NO- Monteringsanvisning
-NL- Montagehandleiding	-SK- Montážny návod	-RU- Руководство по монтажу	-IS- samsetningarleiðbeiningar
-PT- Instruções de montagem	-BG- Инструкция за монтаж	-TR- Montaj Talimatı	

Artikel/Serie Nr.: 95550106x000

Utilisation de la télécommande

Mettez l'interrupteur mural sur « MARCHE ».

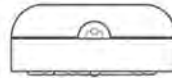

Émetteur de signaux

Veiller à l'absence de rayures et de salissures.

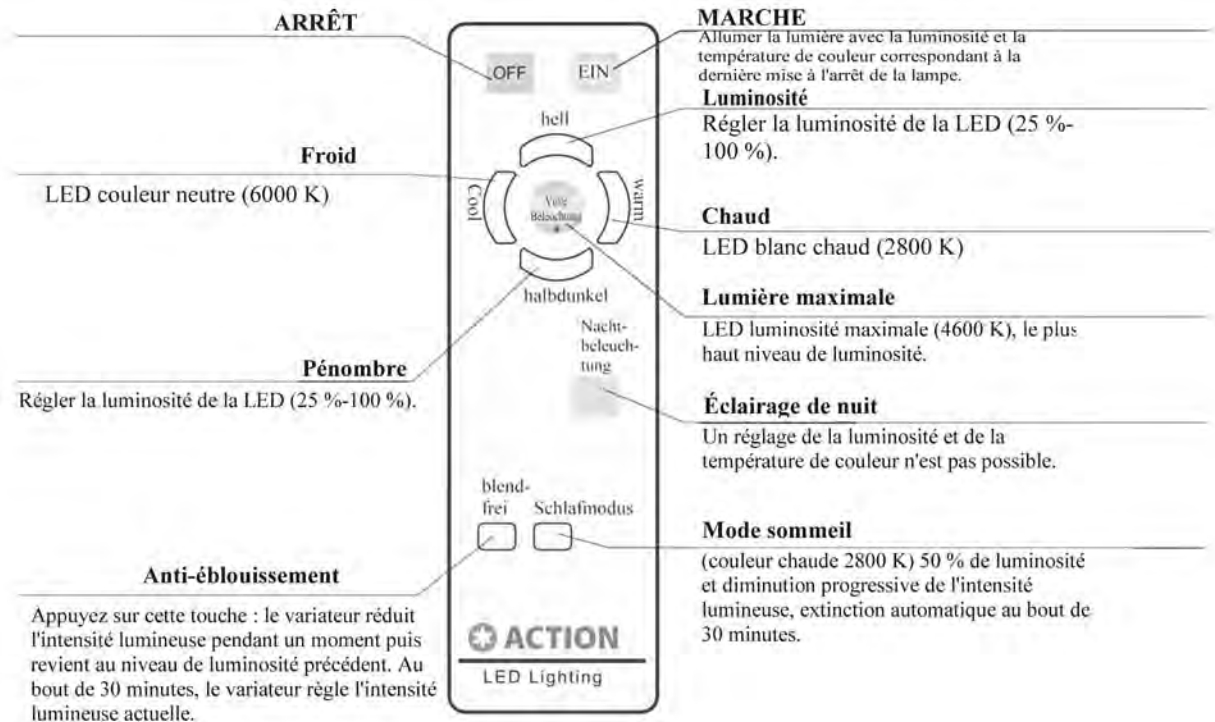

Remarque : lors de l'utilisation de la télécommande, assurez-vous que l'interrupteur mural est sur marche. Sinon, il n'est pas possible d'utiliser la télécommande.

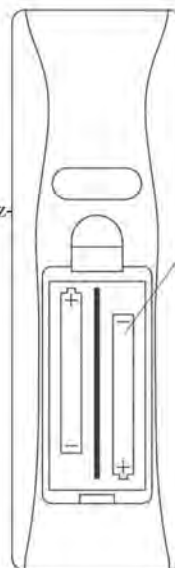

Pile standard

Procédez correctement à l'insertion et au remplacement de la pile. Tenez compte des pôles + et -.

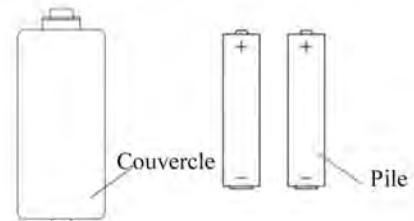

Spécifications de la pile : 7. R03(AAA) 1,5 V, 2 piles