

Lieber Kunde,

wir beglückwünschen Sie zum Kauf dieser Leuchte. Sie haben damit ein Produkt erworben, welches nach dem heutigen Stand der Technik hergestellt wurde.

Damit Sie von Anfang an und solange wie möglich Freude daran haben, lesen Sie bitte sorgfältig vor Inbetriebnahme alle Montage-, Pflege- und Sicherheitshinweise sowie evtl. beiliegende Informationsbroschüren zu besonderen Produkteigenschaften.

Dear Customer,

Congratulations on purchasing this product. You've chosen a product which is built to the highest levels of technical possibilities.

To fully enjoy your new lamp and to maximise it's efficiency, please read and store all installation, care and safety instructions and any other attached information brochures detailing special product features.

Cher Client, Chère cliente,

Nous vous félicitons pour l'achat de ce produit. Vous avez choisi un produit construit avec les techniques les plus sophistiquées.

Pour apprécier votre nouveau produit et pour vous assurer de son efficacité, nous vous remercions de bien vouloir lire toutes les informations de montage, de sécurité et les renseignements notés dans les caractéristiques du produit.



©WOFI LEUCHTEN

Wortmann & Filz GmbH . Im Langel 6 . D-59872 Meschede

+49/(0)2903-449 449 +49/(0)2903 - 449 459 kundendienst@wofi.de www.wofi.de

-DE- Montageanleitung	-LT- Montavimo instrukcija	-HU- Szerelési útmutató	-GR- Οδηγίες τοποθέτησης
-IT- Istruzioni per il montaggio	-LV- Montāžas instrukcija	-RO- Instrucțiuni de montaj	-DK- Montagevejledning
-FR- Instructions de montage	-EE- Paigaldusjuhend	-SI- Navodila za montažo	-FI- Asennusopas
-GB- Installation instructions	-PL- Instrukcja montażu	-HR- Upute za uporabu	-SE- montageinstruktion
-ES- Instrucciones de montaje	-CZ- Návod k montáži	-RS- Uputstva za upotrebu	-NO- Monteringsanvisning
-NL- Montagehandleiding	-SK- Montážny návod	-RU- Руководство по монтажу	-IS- samsetningarleiðbeiningar
-PT- Instruções de montagem	-BG- Инструкция за монтаж	-TR- Montaj Talimatı	

Artikel/Serie Nr.: 977902xx6x00

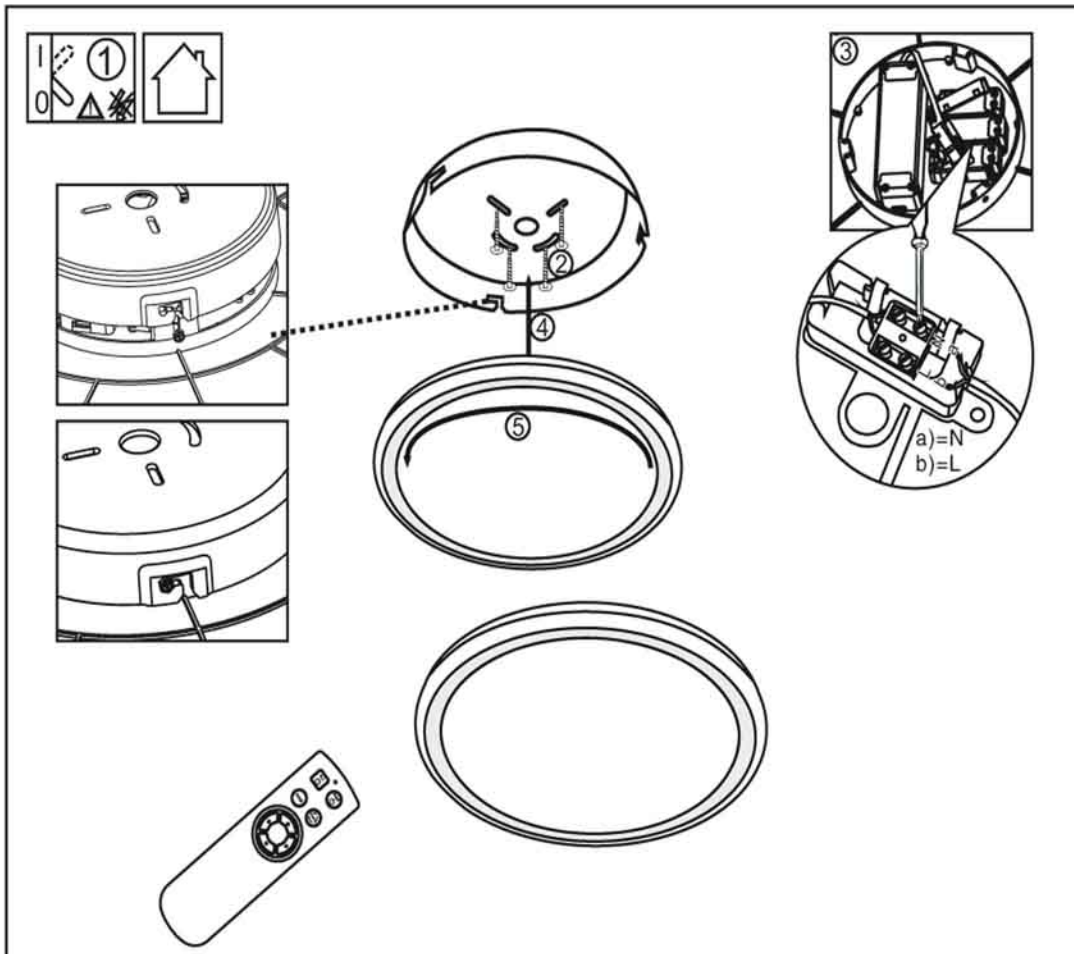
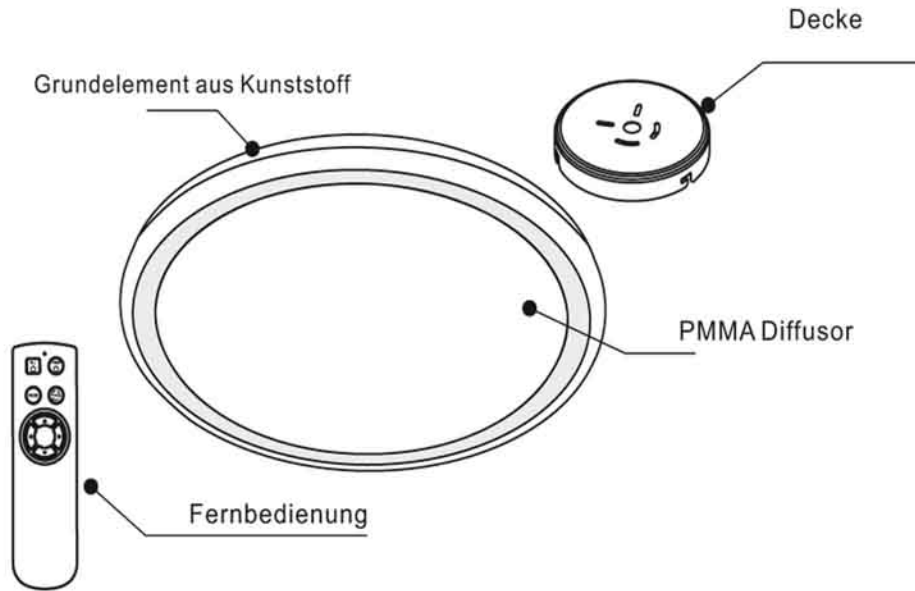

-DE- Montageanleitung	-LT- Montavimo instrukcija	-HU- Szerelési útmutató	-GR- Οδηγίες τοποθέτησης
-IT- Istruzioni per il montaggio	-LV- Montāžas instrukcija	-RO- Instrucțiuni de montaj	-DK- Montagevejledning
-FR- Instructions de montage	-EE- Paigaldusjuhend	-SI- Navodila za montažo	-FI- Asennusopas
-GB- Installation instructions	-PL- Instrukcja montażu	-HR- Upute za uporabu	-SE- montageinstruktion
-ES- Instrucciones de montaje	-CZ- Návod k montáži	-RS- Uputstva za upotrebu	-NO- Monteringsanvisning
-NL- Montagehandleiding	-SK- Montážny návod	-RU- Руководство по монтажу	-IS- samsetningarleiðbeiningar
-PT- Instruções de montagem	-BG- Инструкция за монтаж	-TR- Montaj Talimatı	

Artikel/Serie Nr.: 977902xx6x00

BEDIENUNGSANLEITUNG

Anschluss

1. Installieren Sie bitte die Leuchte entsprechend der Anleitung.
2. Drücken Sie die Taste "  " bis die Leuchte zweimal aufflackert. Damit wird die Verbindung zwischen der Leuchte und der Fernbedingung signalisiert.
3. Um weitere Leuchten mit der Fernbedingung zu verbinden, ist die oben beschriebene Prozedur entsprechend zu wiederholen.



Technical Daten

Betriebsspannung: 3V===

Batterie: 2x1.5V AAA

Reichweite: ca. 6m (im freien Feld)

Bedienungselemente

1. "  ": EIN/AUS-Schalter für das Licht.
2. "  ": EIN/AUS-Schalter für das RGB-Licht.
3. " **RGB** " : Nacheinanderschaltung der RGB-Farben rot/
grün/blau/purpur/gelb.
4. "  " : Automatisches Schalten der RGB-Farben.
5. "  " : Stufenweise Erhöhung der Helligkeit bis 100%.
6. "  " : Stufenweise Reduzierung der Helligkeit bis 10%.
7. "  " : Reduktion der korrelierten Farbtemperatur
(CCT) von 6400K auf 3100K
8. "  " : Erhöhung der korrelierten Farbtemperatur
(CCT) von 3100K auf 6400K

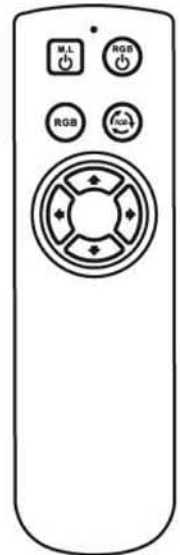

Speichern der Einstellungen

1. Drücken Sie den Wandschalter und lassen Sie die Leuchte mindestens 5 Sekunden eingeschaltet. Bei nächstem Einschalten der Leuchte wird die somit gespeicherte Einstellung wiederverwendet.
2. Schalten Sie den Wandschalter in schneller Abfolge ein und aus. Damit werden die Farben nacheinander wie folgt geändert: CCT-3000K & RGB-4200K & RGB-6400K & RGB - RGB

©WOFI LEUCHTEN

Wortmann & Filz GmbH . Im Langel 6 . D-59872 Meschede

+49/(0)2903-449 449

+49/(0)2903 - 449 459

kundendienst@wofi.de

www.wofi.de

-DE- Montageanleitung	-LT- Montavimo instrukcija	-HU- Szerelési útmutató	-GR- Οδηγίες τοποθέτησης
-IT- Istruzioni per il montaggio	-LV- Montāžas instrukcija	-RO- Instrucțiuni de montaj	-DK- Montagevejledning
-FR- Instructions de montage	-EE- Paigaldusjuhend	-SI- Navodila za montažo	-FI- Asennusopas
-GB- Installation instructions	-PL- Instrukcja montażu	-HR- Upute za uporabu	-SE- montageinstruktion
-ES- Instrucciones de montaje	-CZ- Návod k montáži	-RS- Uputstva za upotrebu	-NO- Monteringsanvisning
-NL- Montagehandleiding	-SK- Montážny návod	-RU- Руководство по монтажу	-IS- samsetningarleiðbeiningar
-PT- Instruções de montagem	-BG- Инструкция за монтаж	-TR- Montaj Talimatı	

Artikel/Serie Nr.: 977902xx6x00

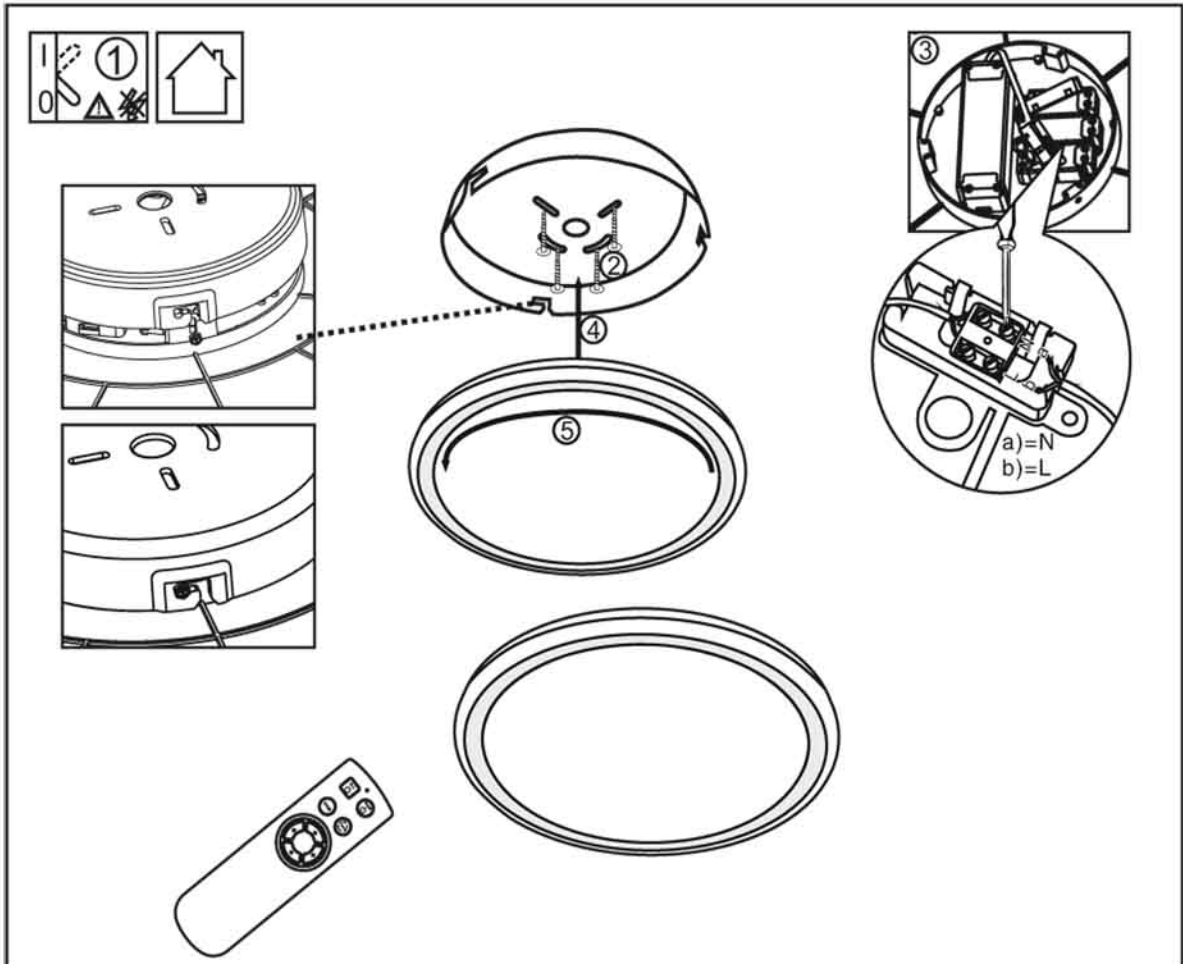
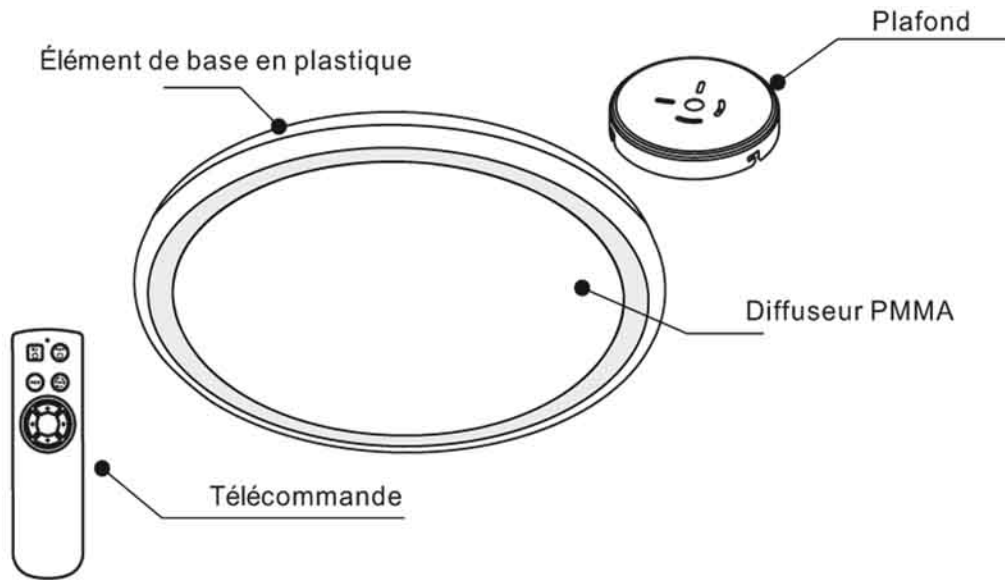

-DE- Montageanleitung	-LT- Montavimo instrukcija	-HU- Szerelési útmutató	-GR- Οδηγίες τοποθέτησης
-IT- Istruzioni per il montaggio	-LV- Montāžas instrukcija	-RO- Instrucțiuni de montaj	-DK- Montagevejledning
-FR- Instructions de montage	-EE- Paigaldusjuhend	-SI- Navodila za montažo	-FI- Asennusopas
-GB- Installation instructions	-PL- Instrukcja montażu	-HR- Upute za uporabu	-SE- montageinstruktion
-ES- Instrucciones de montaje	-CZ- Návod k montáži	-RS- Uputstva za upotrebu	-NO- Monteringsanvisning
-NL- Montagehandleiding	-SK- Montážny návod	-RU- Руководство по монтажу	-IS- samsetningarleiðbeiningar
-PT- Instruções de montagem	-BG- Инструкция за монтаж	-TR- Montaj Talimatı	

Artikel/Serie Nr.: 977902xx6x00

MODE D'EMPLOI







Connexion

1. Veuillez installer la lampe en procédant comme décrit dans les illustrations.
2. Appuyez sur la touche «  » jusqu'à ce que la lampe clignote deux fois. Ce clignotement signale que la lampe et la télécommande sont connectées.
3. Pour connecter d'autres lampes à la télécommande, répétez la procédure décrite ci-dessus.

Caractéristiques techniques

Tension de fonctionnement : 3 V===
Pile : 2x1,5 V AAA
Portée : env. 6 m (en champ libre)

Éléments de commande

1. «  » : interrupteur MARCHÉ/ARRÊT pour la lumière.
2. «  » : interrupteur MARCHÉ/ARRÊT pour la lumière RGB.
3. « **RGB** » : commutation des couleurs RGB dans l'ordre rouge/vert/bleu/pourpre/jaune.
4. «  » : commutation automatique des couleurs RGB.
5. «  » : augmentation progressive de la luminosité jusqu'à 100 %.
6. «  » : réduction progressive de la luminosité jusqu'à 10 %.
7. «  » : réduction de la température de couleur proximale (TCP) de 6400 K à 3100 K
8. «  » : augmentation de la température de couleur proximale (TCP) de 3100 K à 6400 K

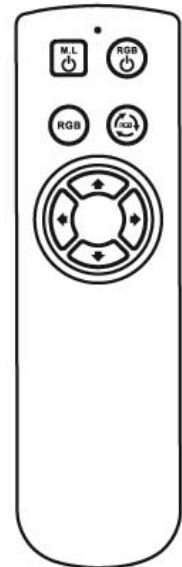

Enregistrement des réglages

1. Appuyez sur l'interrupteur mural et laissez la lampe allumée pendant au moins 5 secondes. Les réglages ainsi enregistrés seront utilisés lorsque vous rallumerez la lampe.
2. Allumez et éteignez plusieurs fois rapidement la lampe avec l'interrupteur mural. Les couleurs sont alors modifiées comme suit : CCT-3000K & RGB-4200K & RGB-6400K & RGB - RGB

-DE- Montageanleitung	-LT- Montavimo instrukcija	-HU- Szerelési útmutató	-GR- Οδηγίες τοποθέτησης
-IT- Istruzioni per il montaggio	-LV- Montāžas instrukcija	-RO- Instrucțiuni de montaj	-DK- Montagevejledning
-FR- Instructions de montage	-EE- Paigaldusjuhend	-SI- Navodila za montažo	-FI- Asennusopas
-GB- Installation instructions	-PL- Instrukcja montażu	-HR- Upute za uporabu	-SE- montageinstruktion
-ES- Instrucciones de montaje	-CZ- Návod k montáži	-RS- Uputstva za upotrebu	-NO- Monteringsanvisning
-NL- Montagehandleiding	-SK- Montážny návod	-RU- Руководство по монтажу	-IS- samsetningarleiðbeiningar
-PT- Instruções de montagem	-BG- Инструкция за монтаж	-TR- Montaj Talimatı	

Artikel/Serie Nr.: 977902xx6x00

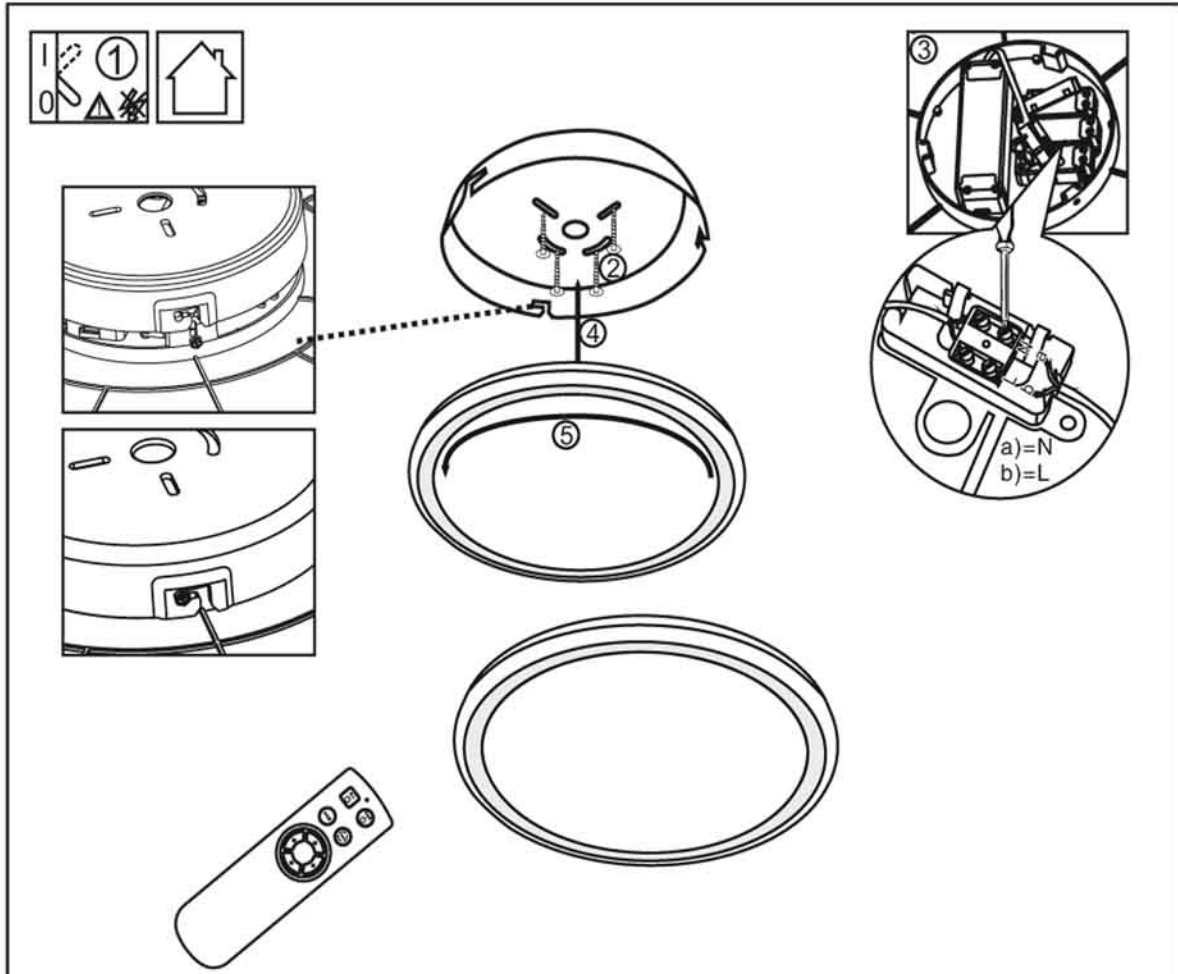
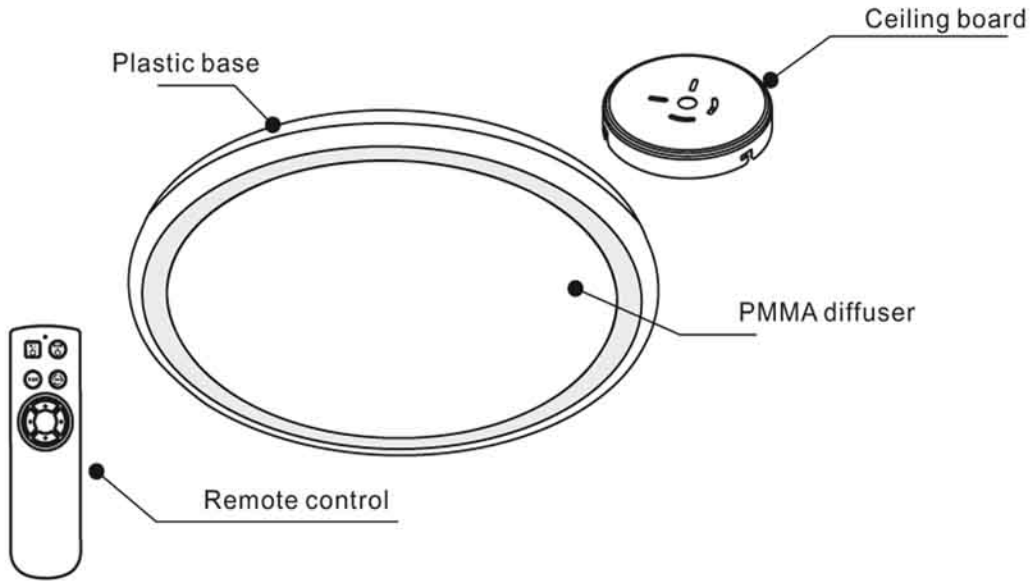

-DE- Montageanleitung	-LT- Montavimo instrukcija	-HU- Szerelési útmutató	-GR- Οδηγίες τοποθέτησης
-IT- Istruzioni per il montaggio	-LV- Montāžas instrukcija	-RO- Instrucțiuni de montaj	-DK- Montagevejledning
-FR- Instructions de montage	-EE- Paigaldusjuhend	-SI- Navodila za montažo	-FI- Asennusopas
-GB- Installation instructions	-PL- Instrukcja montażu	-HR- Upute za uporabu	-SE- montageinstruktion
-ES- Instrucciones de montaje	-CZ- Návod k montáži	-RS- Uputstva za upotrebu	-NO- Monteringsanvisning
-NL- Montagehandleiding	-SK- Montážny návod	-RU- Руководство по монтажу	-IS- samsetningarleiðbeiningar
-PT- Instruções de montagem	-BG- Инструкция за монтаж	-TR- Montaj Talimatı	

Artikel/Serie Nr.: 977902xx6x00

INSTRUCTION MANUAL







Connection

1. Install the luminaire according to the manual.
2. Press “” button until the luminaire will be flickering for two times to connect luminary and remote control.
3. If you want to connect another luminaire to the same remote control please repeat the procedure.

Caractéristiques techniques

Operating voltage: 3V===
 Battery: 2x1.5V AAA
 Range: app. 6m (freefield)

Button Instruction

1. “” : Switch ON/OFF the light.
2. “” : Switch ON/OFF the deco RGB light.
3. “**RGB**” : Shift RGB light to be red/green/blue/purple/yellow.
4. “” : Change of color- RGB light automatically.
5. “” : Increase the brightness gradually up to 100%.
6. “” : Decrease the brightness gradually drop to 10%.
7. “” : Drop CCT from 6400K to 3000K
8. “” : Rise CCT from 3000K to 6400K



Memory function

1. Use wall switch turn on the lamp and keep working over 5 seconds, next switch will always memorize the last status.
2. Use the wall switch quickly ON/OFF for color change CCT-3000K & RGB-4200K & RGB-6400K & RGB - RGB

-DE- Montageanleitung	-LT- Montavimo instrukcija	-HU- Szerelési útmutató	-GR- Οδηγίες τοποθέτησης
-IT- Istruzioni per il montaggio	-LV- Montāžas instrukcija	-RO- Instrucțiuni de montaj	-DK- Montagevejledning
-FR- Instructions de montage	-EE- Paigaldusjuhend	-SI- Navodila za montažo	-FI- Asennusopas
-GB- Installation instructions	-PL- Instrukcja montażu	-HR- Upute za uporabu	-SE- montageinstruktion
-ES- Instrucciones de montaje	-CZ- Návod k montáži	-RS- Uputstva za upotrebu	-NO- Monteringsanvisning
-NL- Montagehandleiding	-SK- Montážny návod	-RU- Руководство по монтажу	-IS- samsetningarleiðbeiningar
-PT- Instruções de montagem	-BG- Инструкция за монтаж	-TR- Montaj Talimatı	

Artikel/Serie Nr.: 977902xx6x00

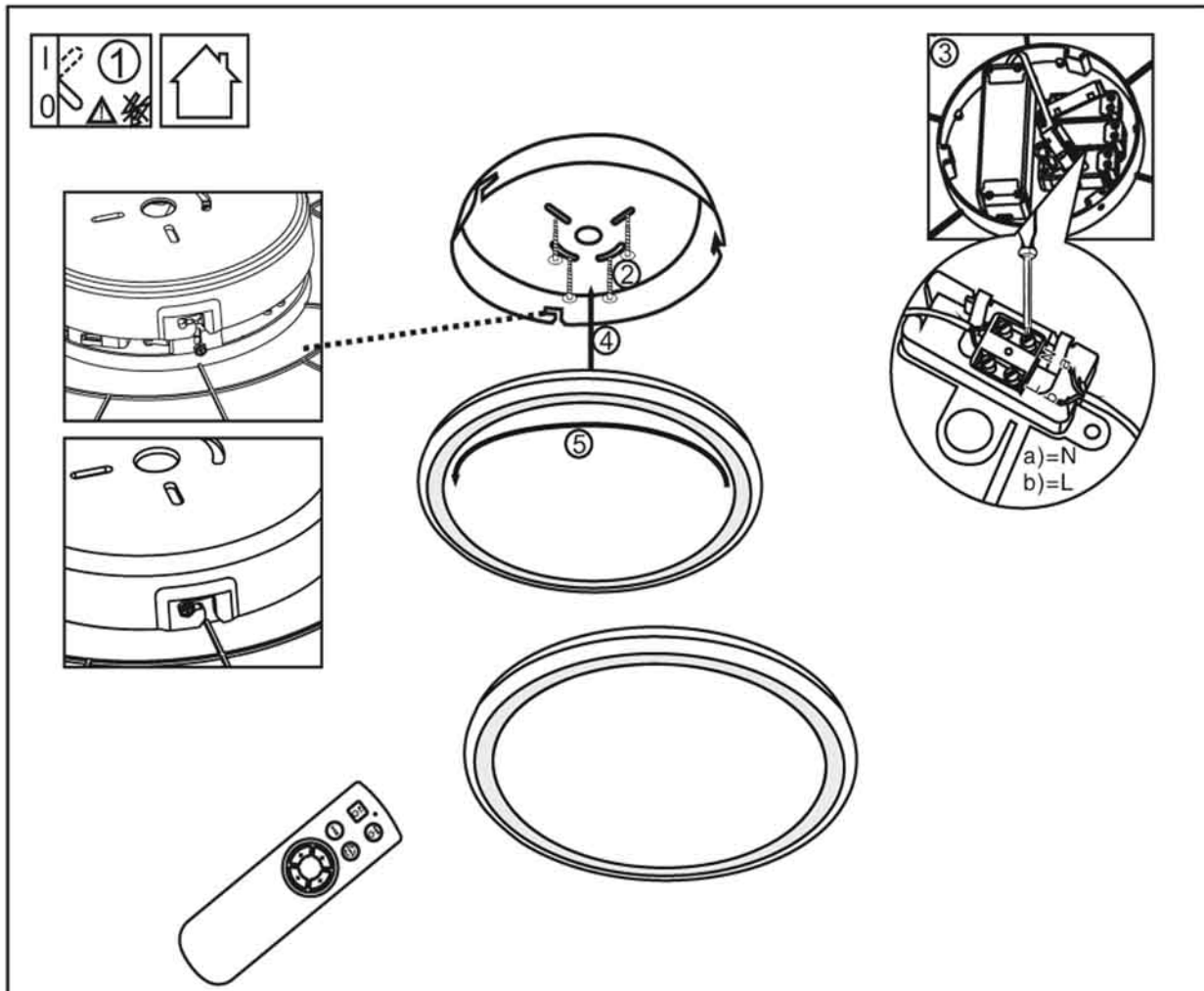
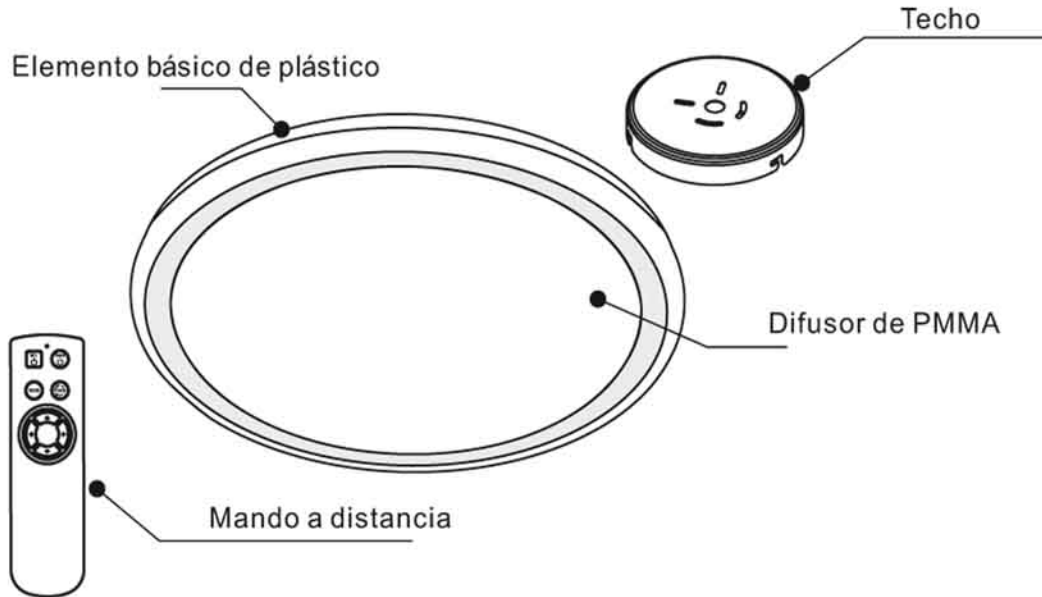

-DE- Montageanleitung	-LT- Montavimo instrukcija	-HU- Szerelési útmutató	-GR- Οδηγίες τοποθέτησης
-IT- Istruzioni per il montaggio	-LV- Montāžas instrukcija	-RO- Instrucțiuni de montaj	-DK- Montagevejledning
-FR- Instructions de montage	-EE- Paigaldusjuhend	-SI- Navodila za montažo	-FI- Asennusopas
-GB- Installation instructions	-PL- Instrukcja montażu	-HR- Upute za uporabu	-SE- montageinstruktion
-ES- Instrucciones de montaje	-CZ- Návod k montáži	-RS- Uputstva za upotrebu	-NO- Monteringsanvisning
-NL- Montagehandleiding	-SK- Montážny návod	-RU- Руководство по монтажу	-IS- samsetningarleiðbeiningar
-PT- Instruções de montagem	-BG- Инструкция за монтаж	-TR- Montaj Talimatı	

Artikel/Serie Nr.: 977902xx6x00

MANUAL DE INSTRUCCIONES

Conexión

1. Instale la lámpara según lo especificado en el manual de instrucciones.
2. Presione la tecla "  " hasta que la lámpara se ilumine dos veces. De este modo se señala que hay conexión entre la lámpara y el mando a distancia.
3. Para conectar otras lámparas al mando a distancia, se tiene que repetir el procedimiento arriba descrito.









Datos técnicos

Tensión de servicio: 3V===

Batería: 2x1,5V AAA

Alcance: aprox. 6m (en campo abierto)

Elementos de mando

1. "  ": Interruptor de ENCENDIDO/APAGADO para la luz.
2. "  ": Interruptor de ENCENDIDO/APAGADO para la luz RGB.
3. "  ": Conexión secuencial de los colores RGB rojo/verde/azul/púrpura/amarillo.
4. "  ": Conexión automática de los colores RGB.
5. "  ": Aumento escalonado del brillo hasta 100%.
6. "  ": Reducción escalonada del brillo hasta 10%.
7. "  ": Reducción de la temperatura de color correlacionada (CCT) de 6400K a 3100K
8. "  ": Aumento de la temperatura de color correlacionada (CCT) de 3100K a 6400K

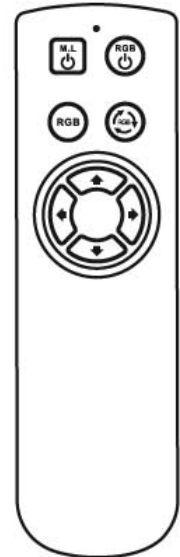

Almacenamiento de los ajustes

1. Presione el interruptor de pared y deje la lámpara al menos 5 segundos encendida. Al encender la lámpara la próxima vez, se utilizarán los ajustes almacenados de esta manera.
2. Encienda y apague el interruptor de pared en sucesión rápida. Con ello, los colores cambiarán sucesivamente de la siguiente manera: CCT-3000K & RGB-4200K & RGB-6400K & RGB - RGB