

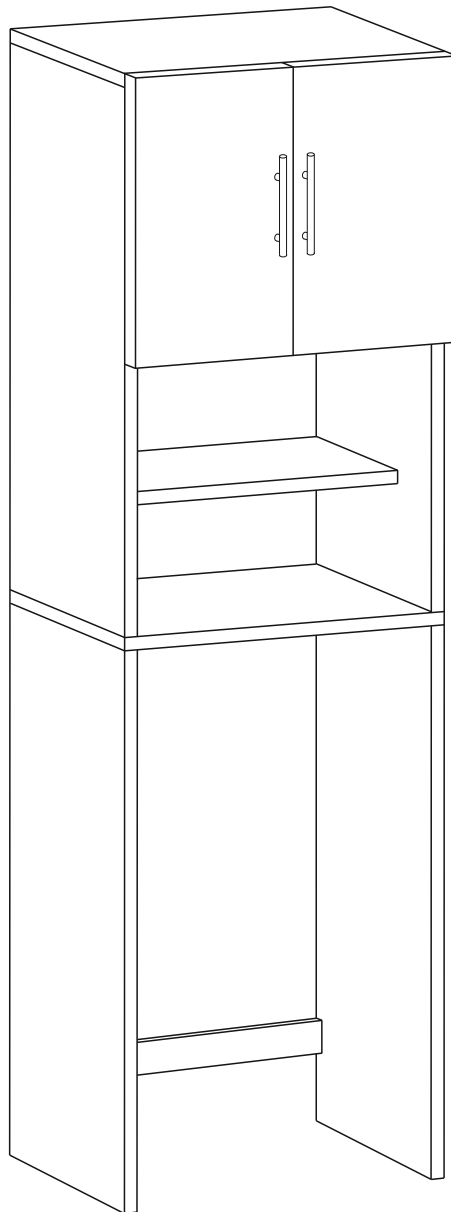

## VCM Waschmaschinenüberbau "Jutas"

1,90m/ 0,64m/ 0,25m



**Achtung: Bei mangelhafter Montage besteht Gefahr für die Sicherheit.  
Möbel unbedingt an der Wand montieren!!!!**

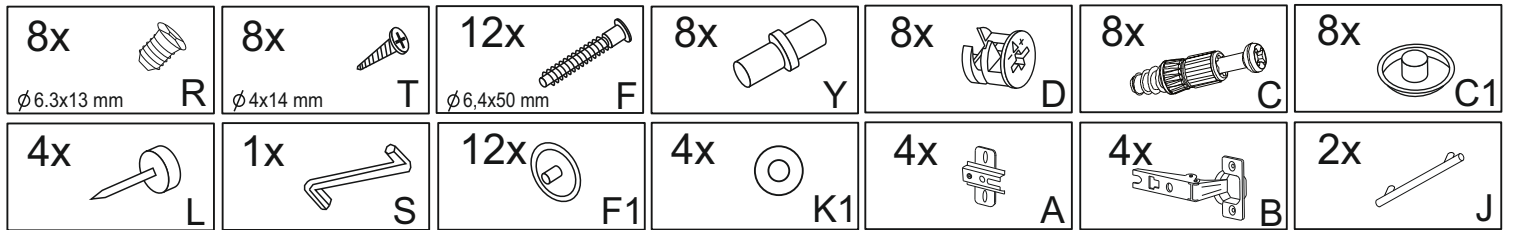

**Achtung! Verschluckbare Kleinteile enthalten.  
Erstickungsgefahr. Kinder nicht unbeaufsichtigt in  
der Nähe des Möbelstückes lassen.  
Warning! Swallowable small parts enclosed.  
Danger of suffocation. Do not leave children  
unattended near furniture.**

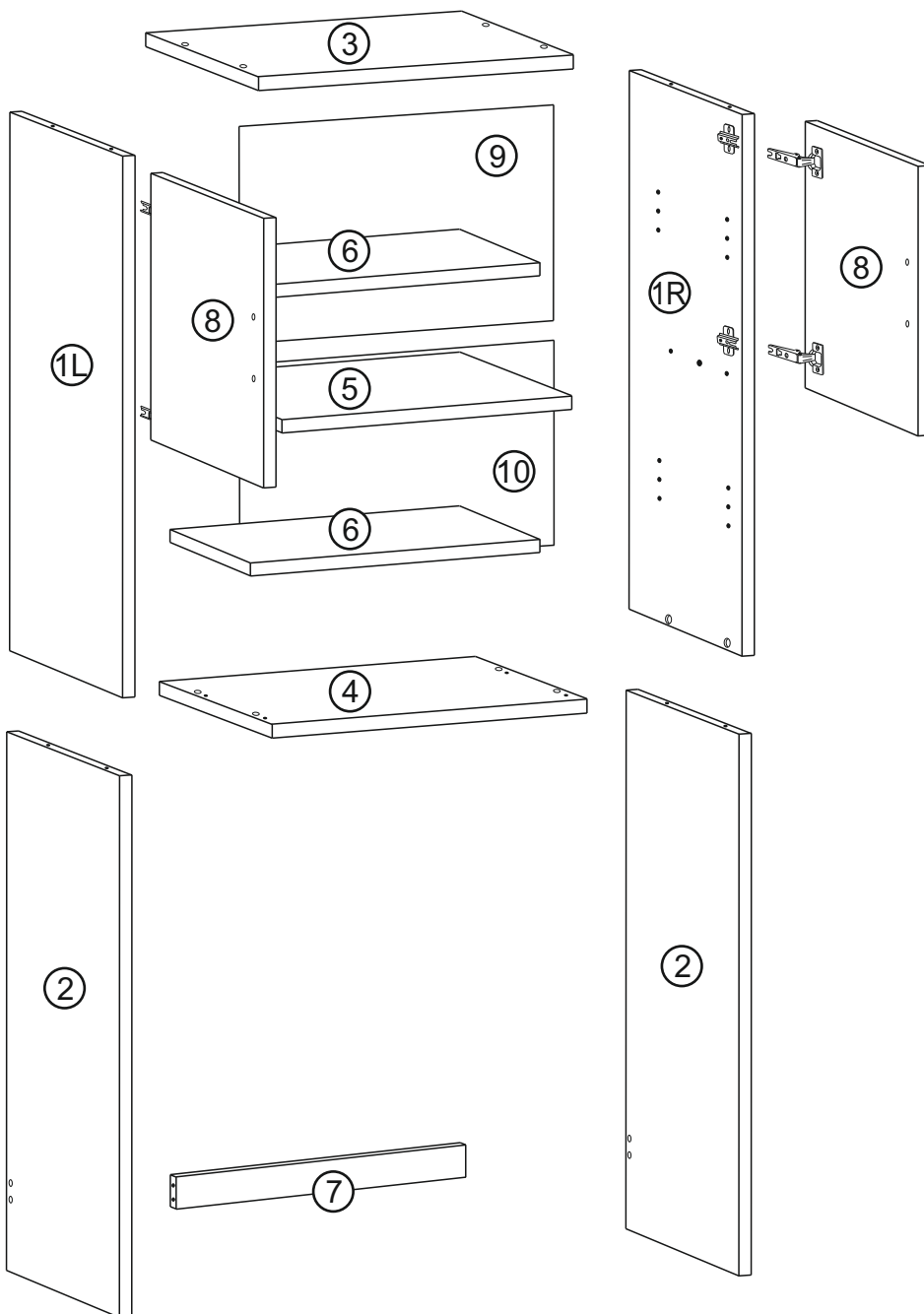
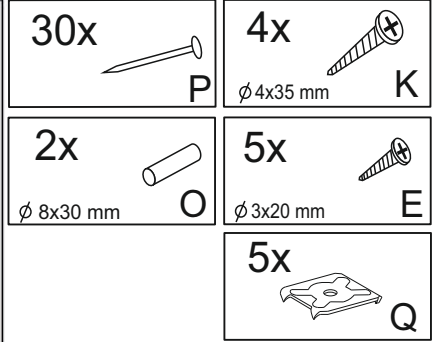

1L,1R	932x250x16
2,2	932x250x16
3,4	642x250x16
5	480x250x16
6,6	608x234x16
7	608x108x16
8,8	496x316x16
9	486x636
10	474x636

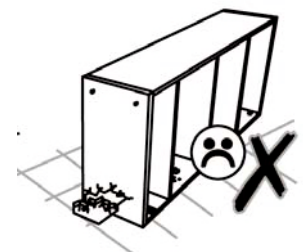
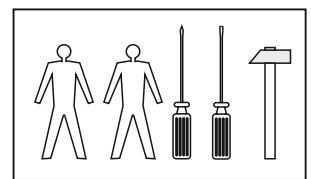

# 1

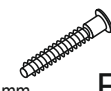
4x   $\phi 6,4 \times 50$  mm F

4x  F1

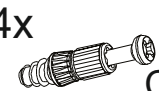
4x  C

4x  A

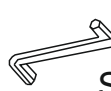
1x  S

8x   $\phi 6.3 \times 13$  mm R

8x   $\phi 8 \times 30$  mm O

4x  D

8x  C1

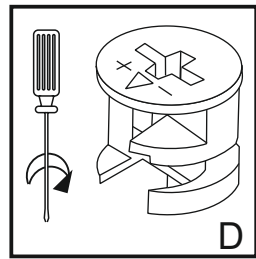
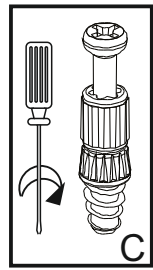
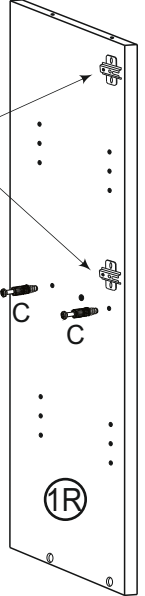
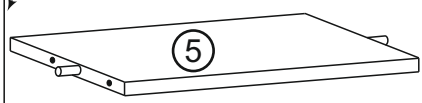
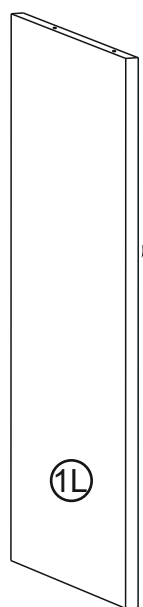
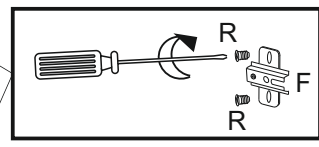
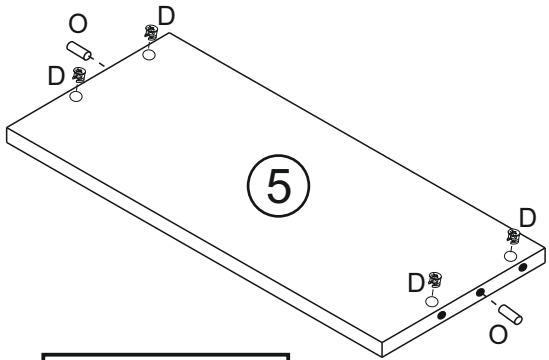
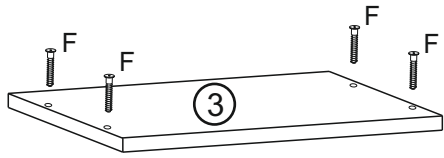
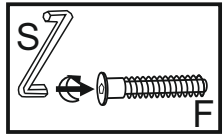

# 2

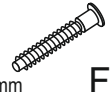
8x   $\phi 6,4 \times 50$  mm F

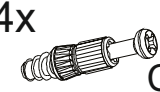
4x  C

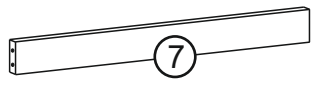
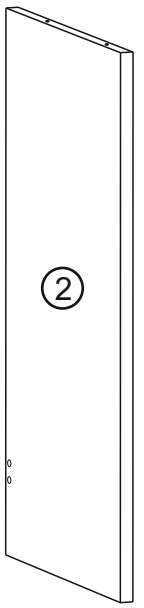
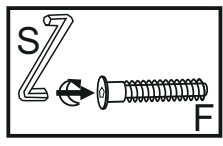
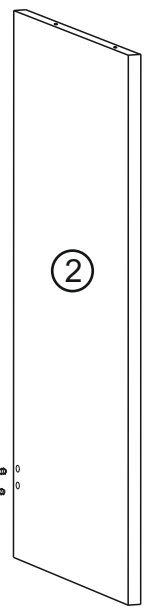
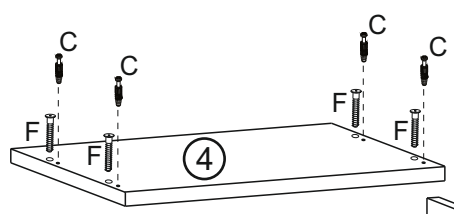
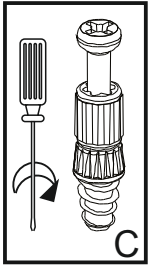

# 3

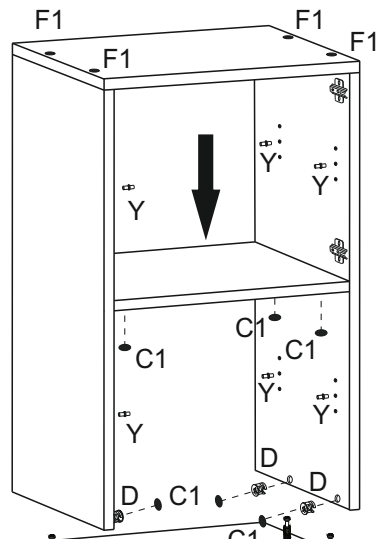

4x  D

8x  C1

8x  F1

8x  Y

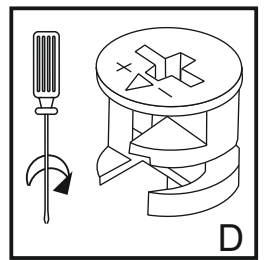
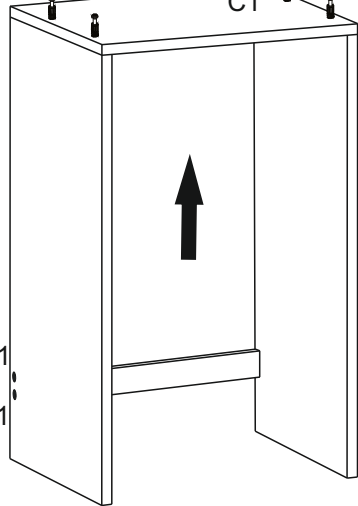

**3**

4x



5x



30x



5x

ø 3x20 mm

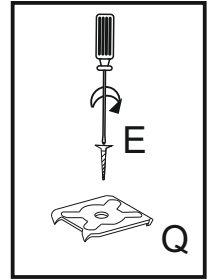
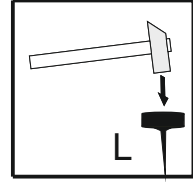
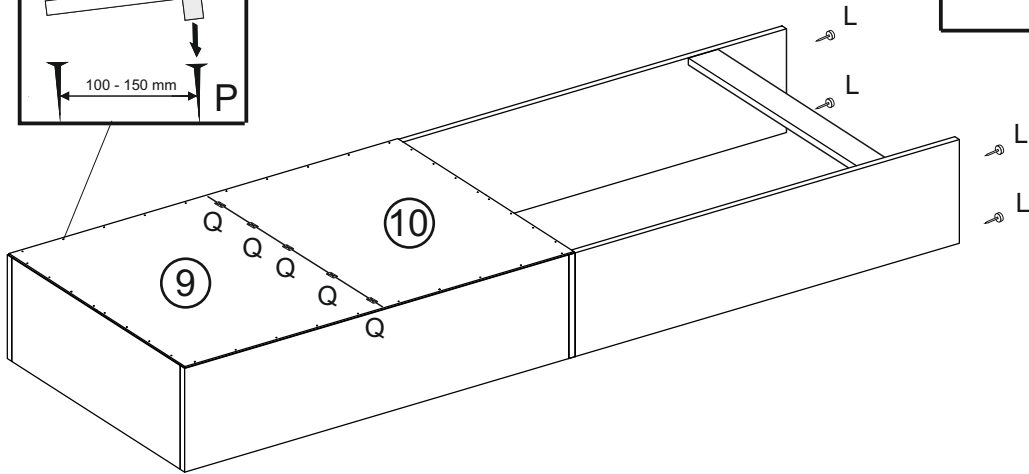
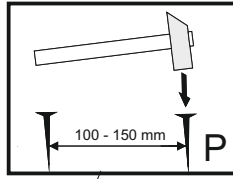
**4**

4x

ø 4x35 mm

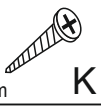

2x



4x

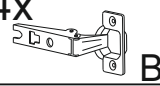

8x

ø 4x14 mm



4x

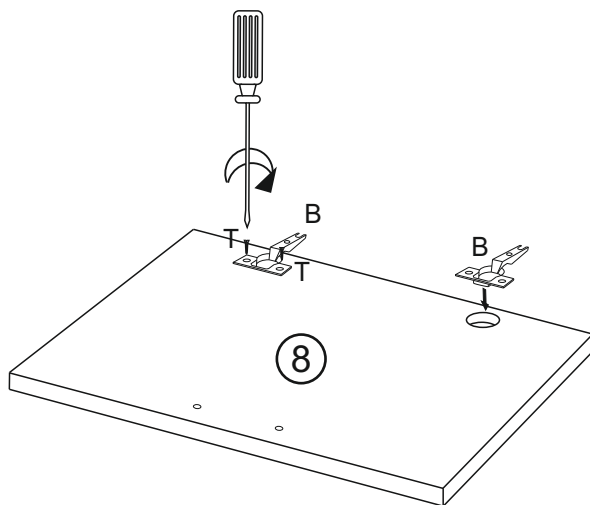
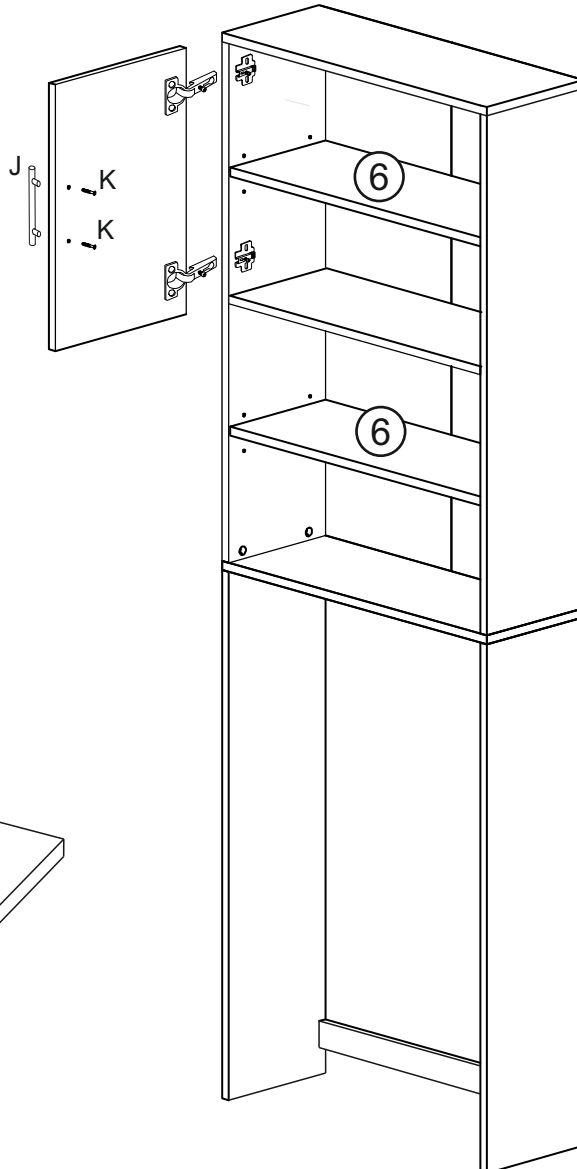
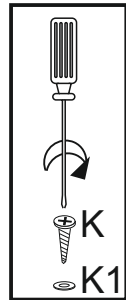



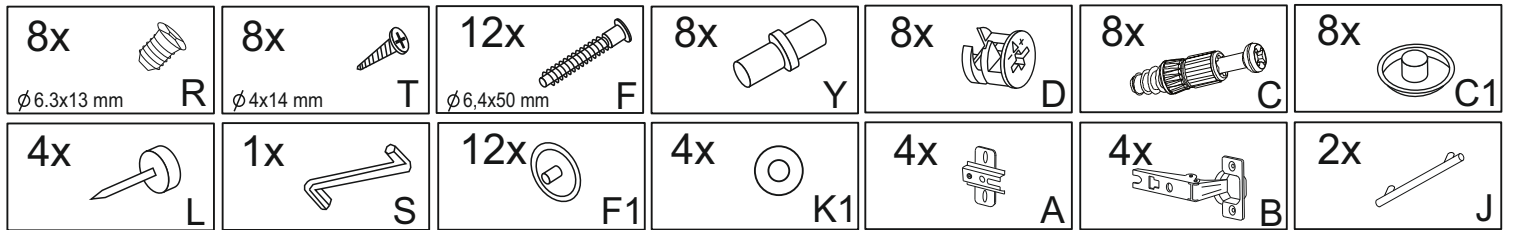

**Achtung! Verschluckbare Kleinteile enthalten.  
Erstickungsgefahr. Kinder nicht unbeaufsichtigt in  
der Nähe des Möbelstückes lassen.  
Warning! Swallowable small parts enclosed.  
Danger of suffocation. Do not leave children  
unattended near furniture.**

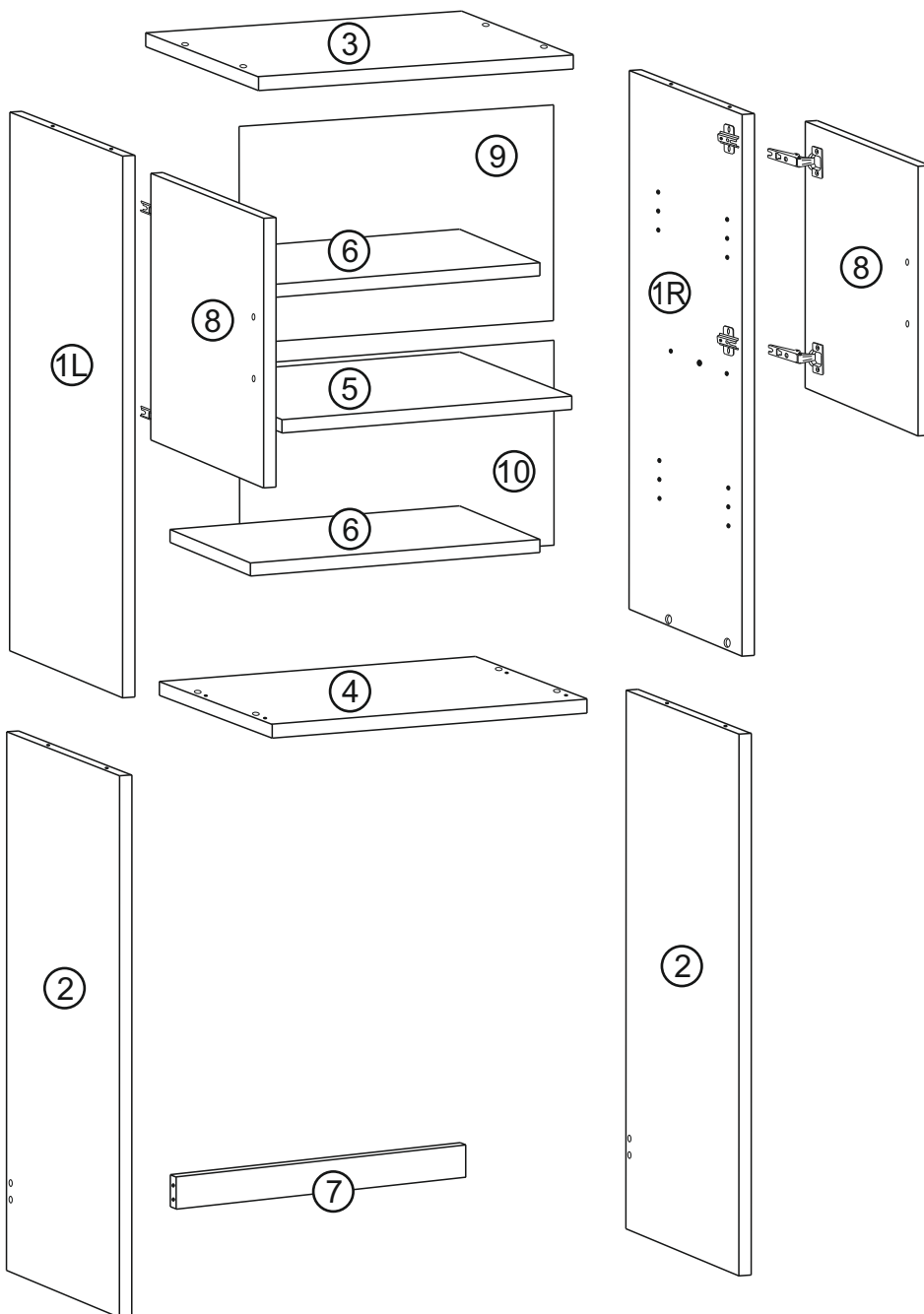
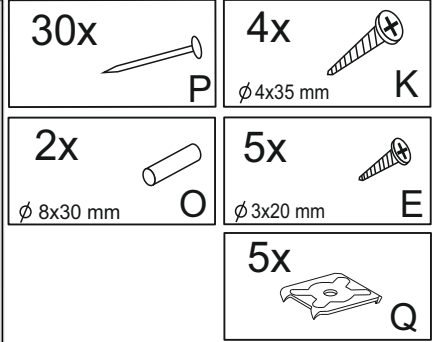

1L,1R	932x250x16
2,2	932x250x16
3,4	642x250x16
5	480x250x16
6,6	608x234x16
7	608x108x16
8,8	496x316x16
9	486x636
10	474x636

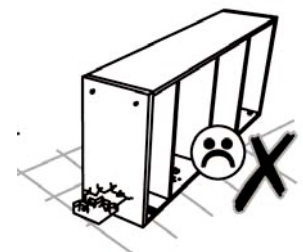
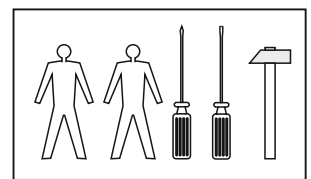

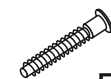

# 1

4x   $\phi 6,4 \times 50$  mm F

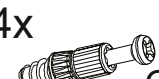
4x  F1

4x  C

4x  A

1x  S

8x   $\phi 6.3 \times 13$  mm R

8x   $\phi 8 \times 30$  mm O

4x  D

8x  C1

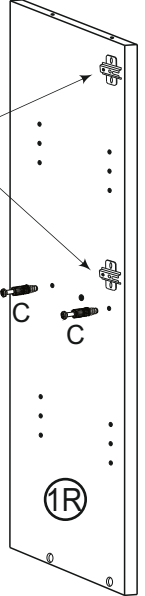
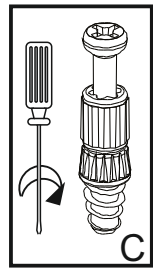
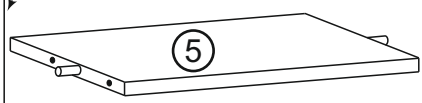
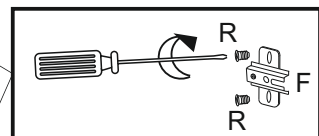
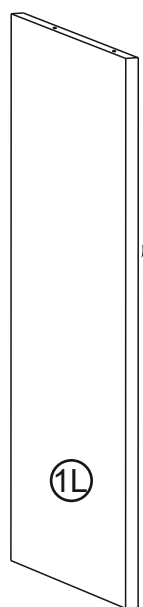
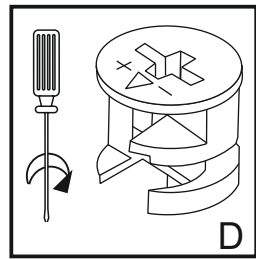
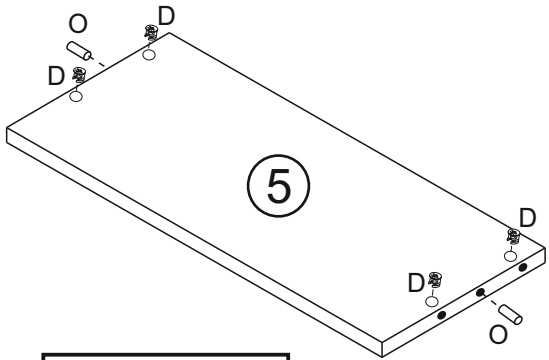
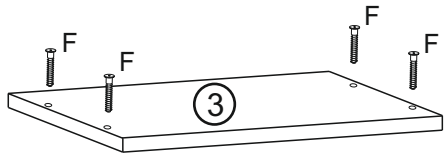
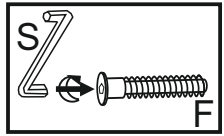

# 2

8x   $\phi 6,4 \times 50$  mm F

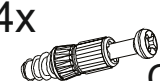
4x  C

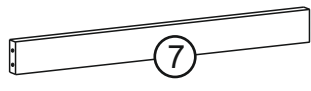
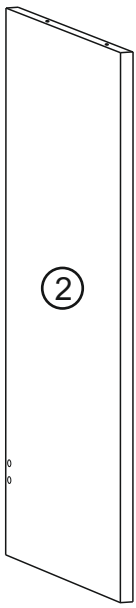
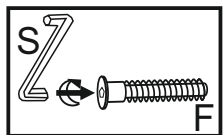
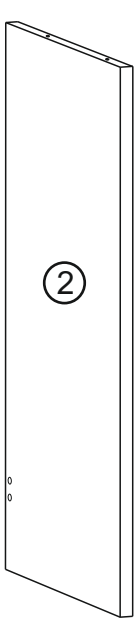
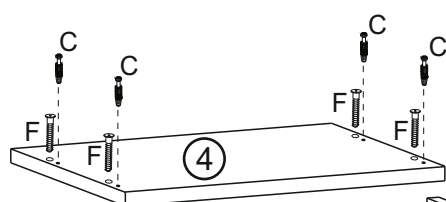
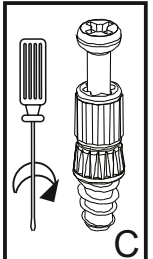

# 3

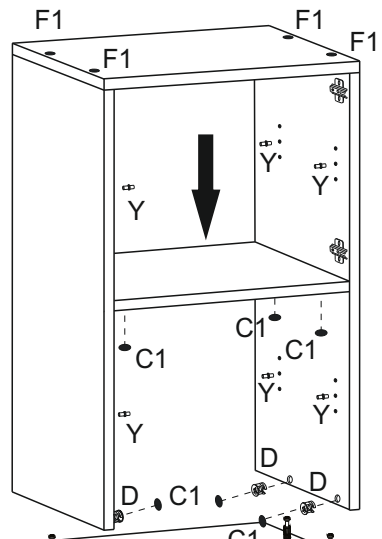

4x  D

8x  C1

8x  F1

8x  Y

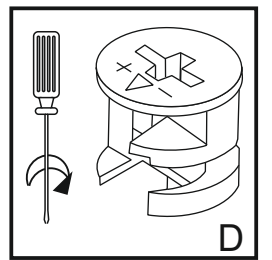
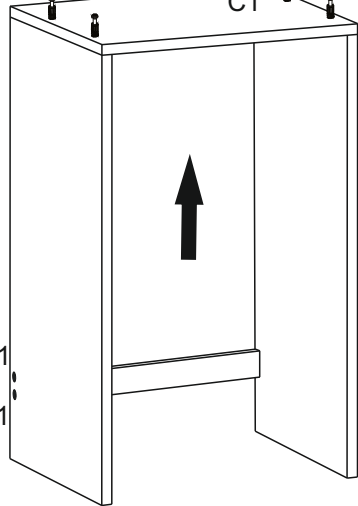

**3**

4x

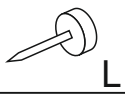

5x



30x



5x

ø 3x20 mm

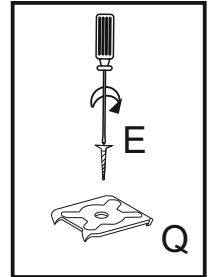
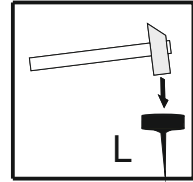
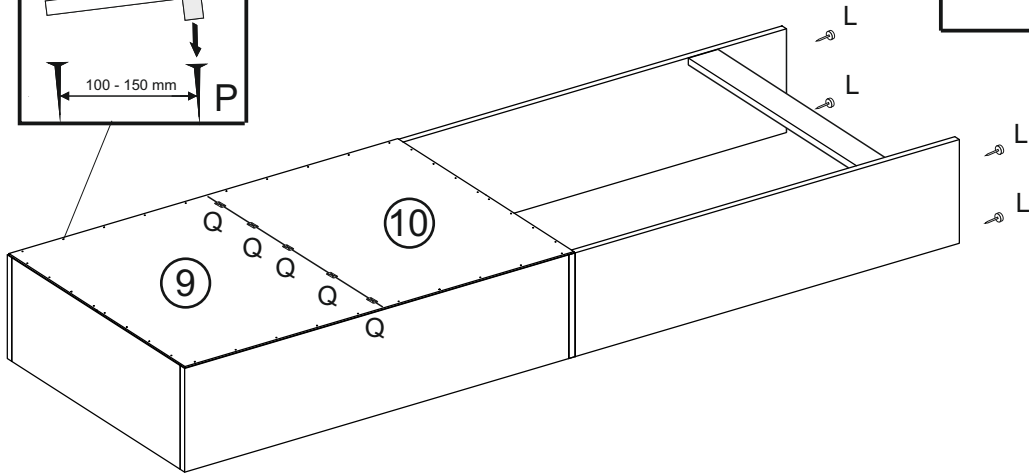
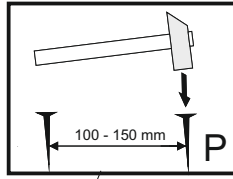

E

**4**

4x

ø 4x35 mm

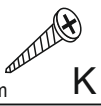

2x



J

4x

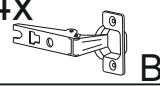

B

8x

ø 4x14 mm



T

4x



K1

