

Dantos 1
Art. Nr. 2830796
1/1 Á

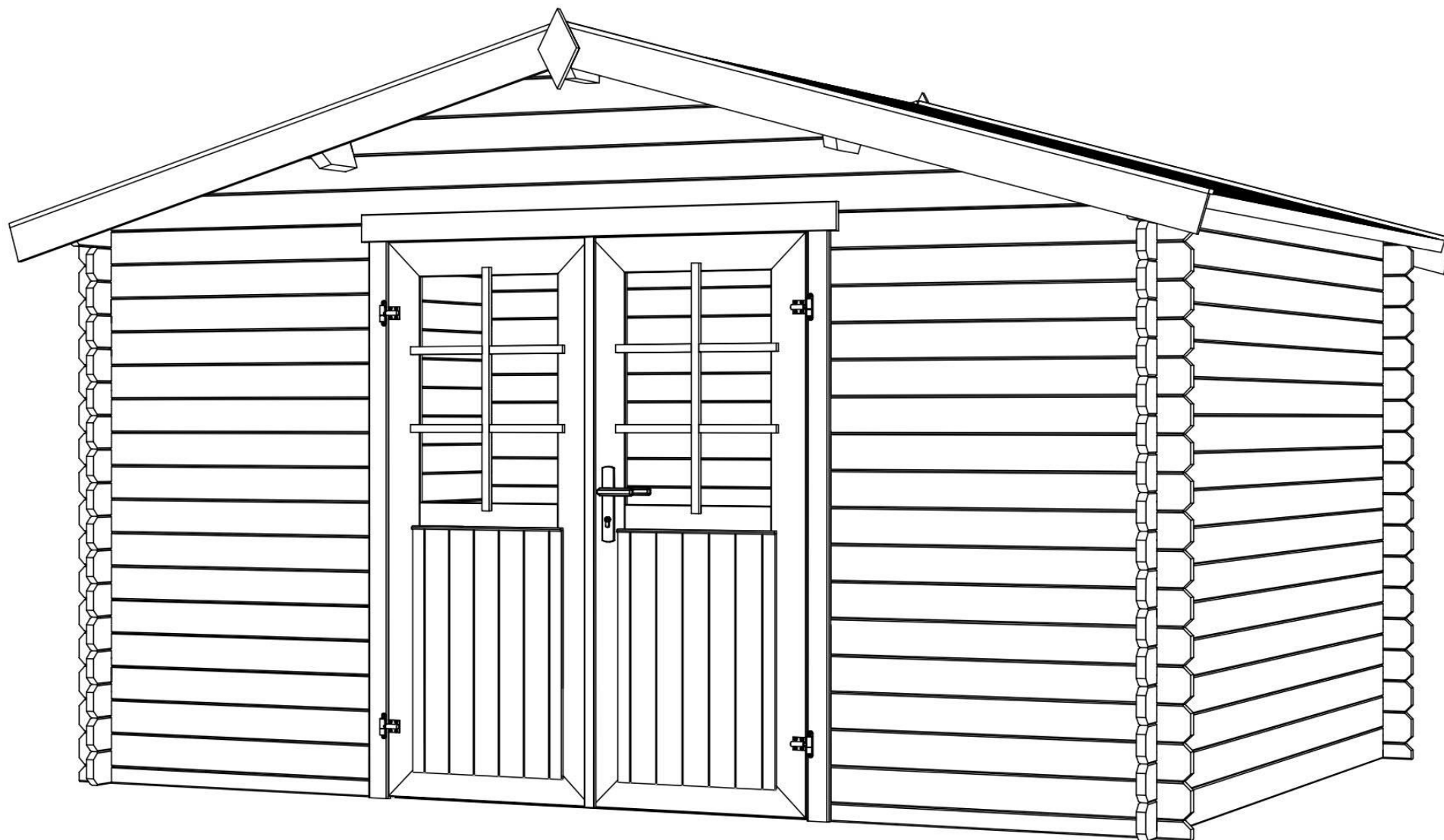

11.10.2017

Groundplan - Grundplan - Plan de masse - Planimetria -
Plattegrond - Põhiplaan

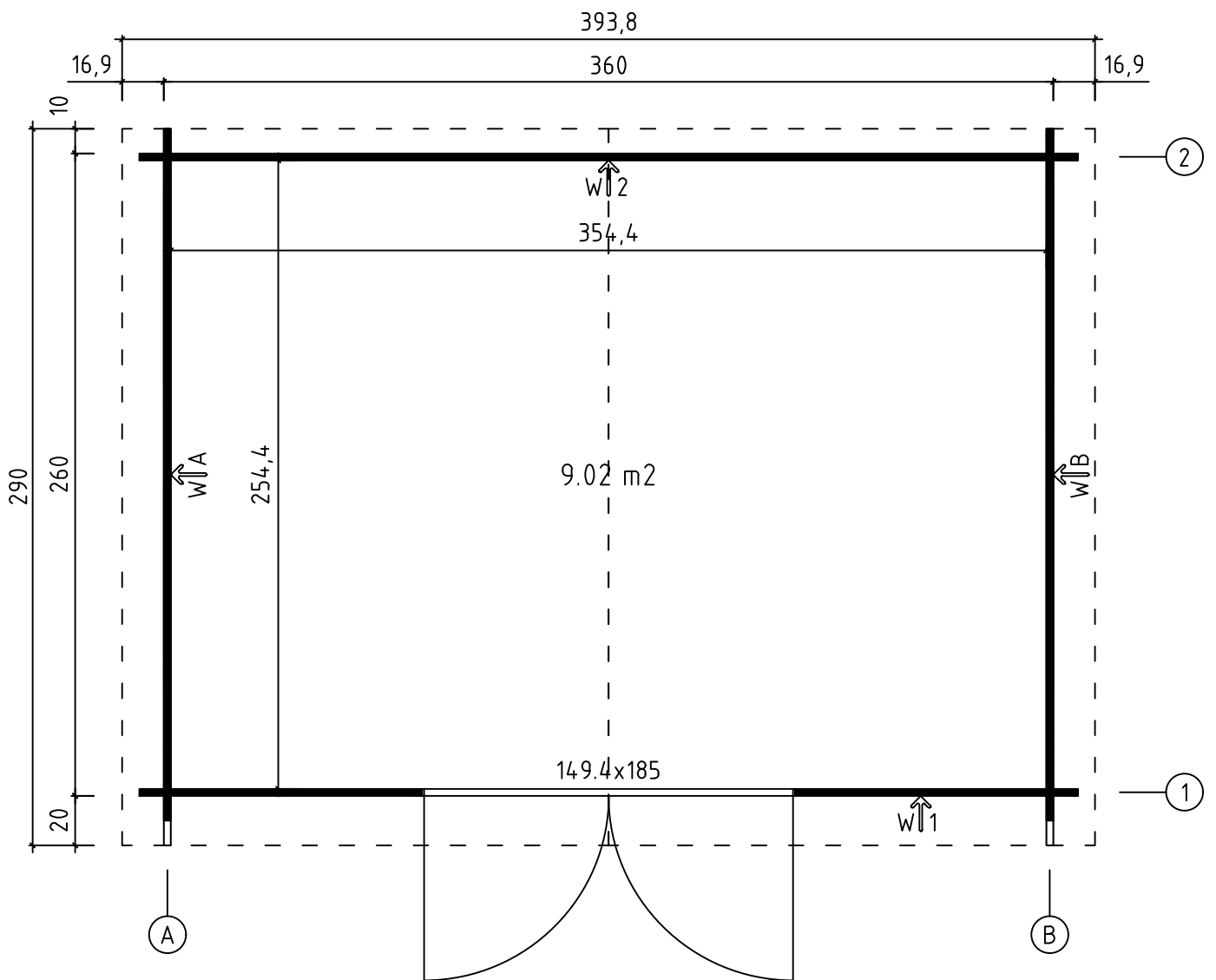



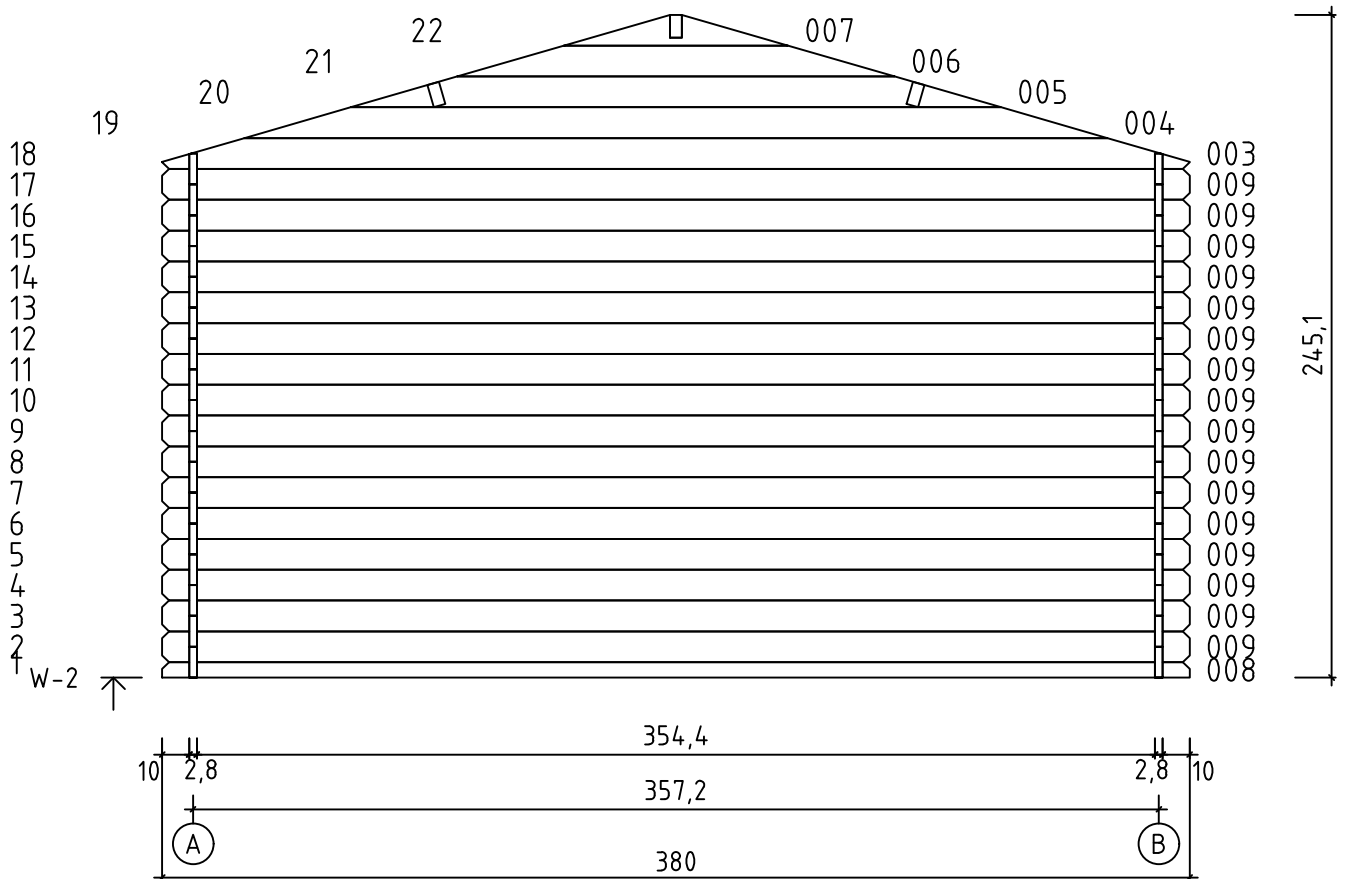
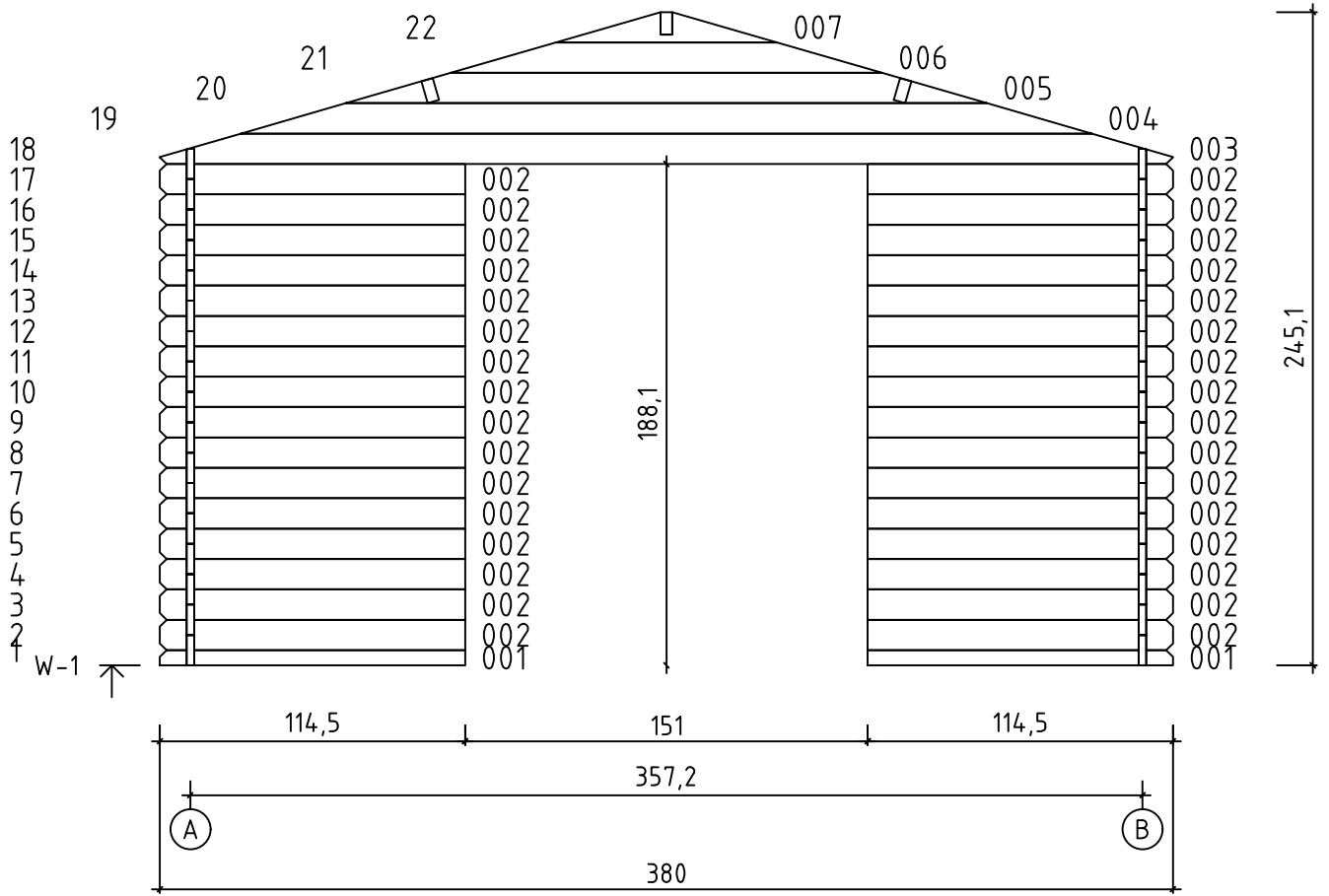



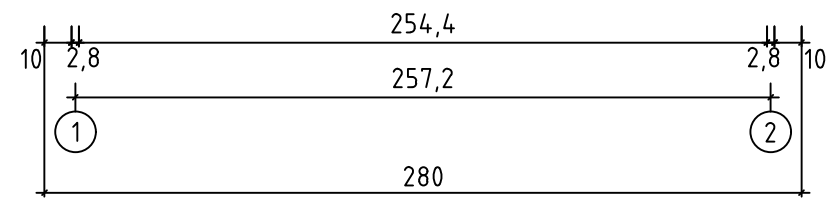
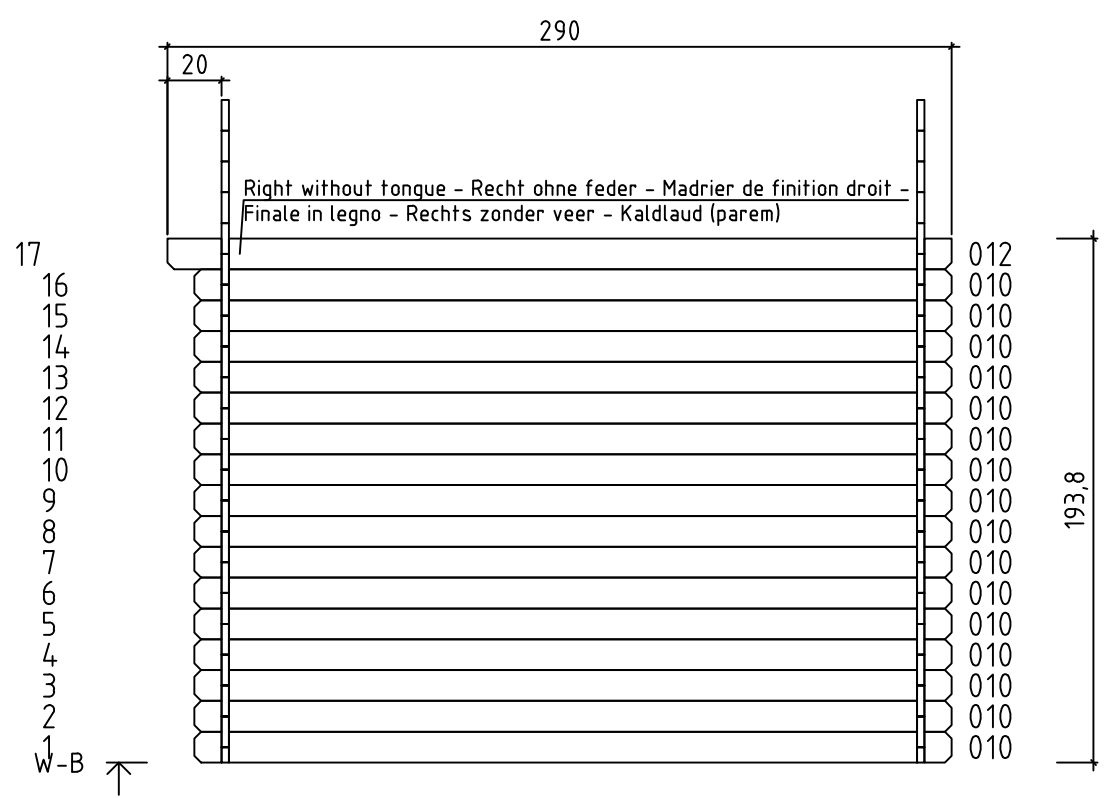
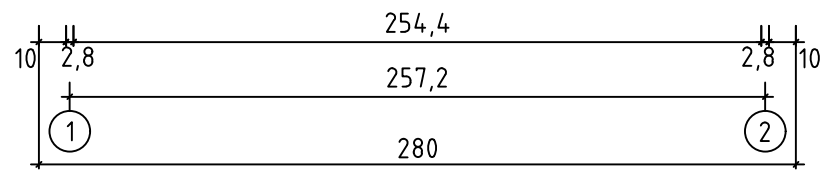
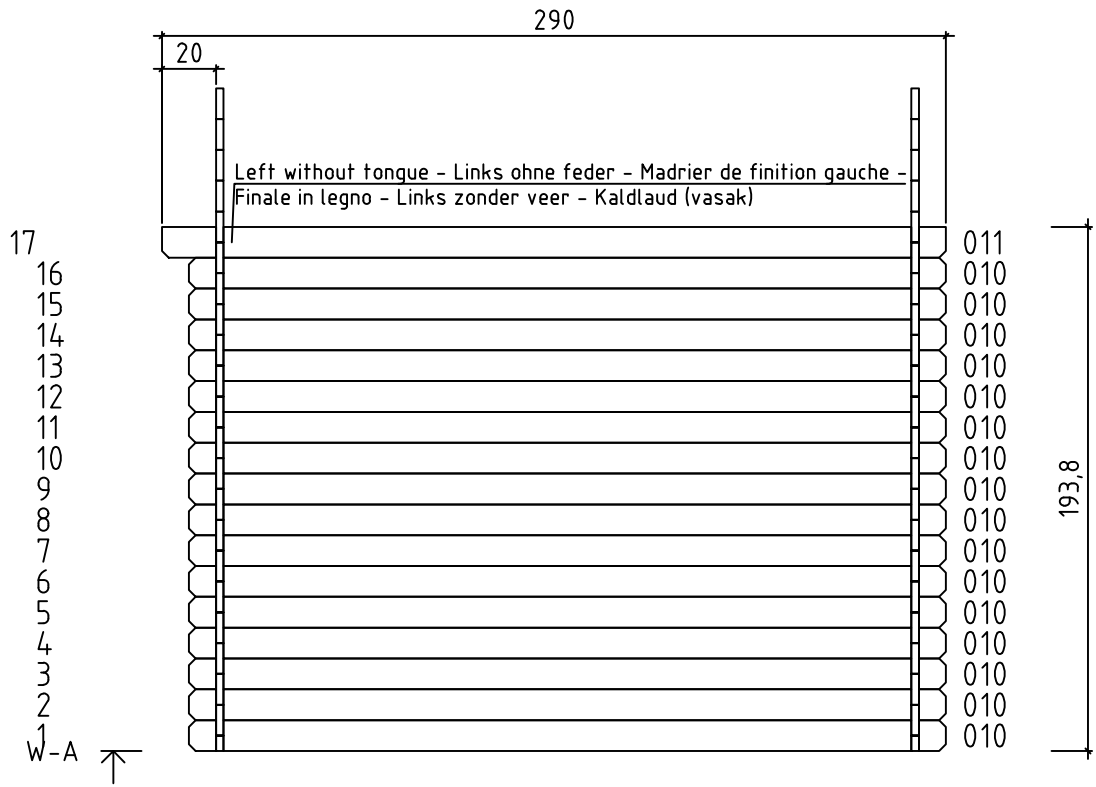

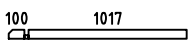
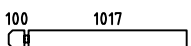
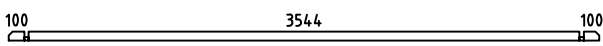
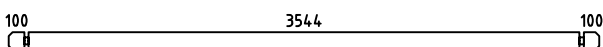
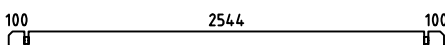
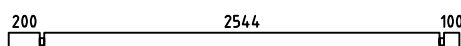
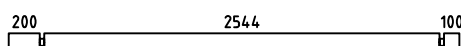
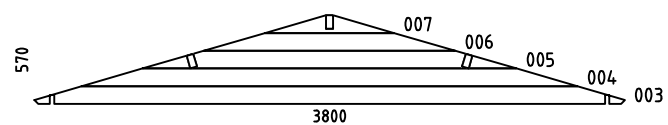
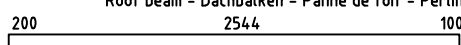

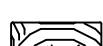
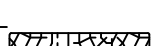
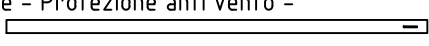
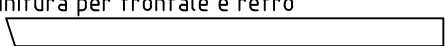
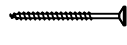



Art. Nr. 2830796

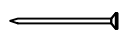

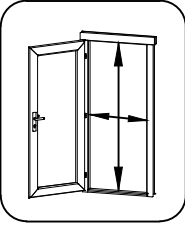
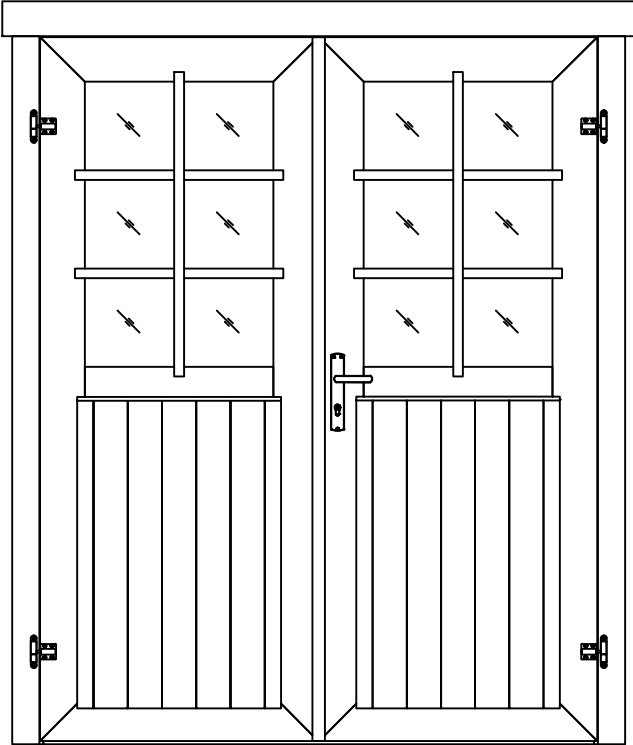
Art. Nr. 2830796

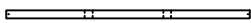
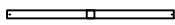

Pos	11.10.2017 Piece list - Stückliste - Liste des pièces - Elementi - Stuklijst - Tükítabel Art. Nr. 2830796 5/6	Q	P (mm)	L (mm)
001		2	28x57	1145
002		32	28x114	1145
008		1	28x57	3800
009		16	28x114	3800
010		32	28x114	2800
011		1	28x120	2900
012		1	28x120	2900
W1-1 W2-1		1 1		
A-PR1	Roof beam - Dachbalken - Panne de toit - Perlina del tetto - Gordingen / dakbalk - Pärlin 	3	44x140	2900
	Roof boards - Dachbretter - Voliges - Perlina per tetto - Dakhout - Katuselaud 	66	90x15	2050
	Roofing felt fillet - Dachpappenleiste - Baguette de fixation du feutre bitumeux - Asse per fissaggio guaina bituminosa - Afdekljst asfaltpapier - Katusepapiilist 	4	15x45	2100
TB-1	Fascia board - Traufbrett - Bandeau de toit - Finitura lati tetto - Gevellijst - Räästalaud 	2	15x45	2900
KFS-1	Storm protection - Sturmleiste - Latte anti-tempete - Protezione anti vento - Stormverankering / beveliging - Tormikinnitusliist 	4	22x45	2050
	Gable moulding - Giebelleiste - Planche de rive - Finitura per frontale e retro del tetto - Gevellijst - Viilulaud 	4	15x120	2100
HS8	Screw for gable segment - Schrauben für deckblatt - Vis pour fixation losange de finition - Viti x frontali tetto - Schroef voor gevelpunt segment - Kruvi rombile 	4	3.5x35	
HS9	Screw for gable moulding - Schrauben für giebelleiste - Vis pour fixation planche de rive - Vite per fissare finiture davanti e dietro del tetto - Schroef voor gevellijst - Kruvi viilulauale 	24	3.5x50	
HS4	Screw for fascia boards - Schrauben für traufbretter - Vis pour fixation bandeau de toit - Viti x striscia del tetto - Schroef voor gevellijst - Kruvi räästalauale 	14	3x30	
HS18	Screw for roof beams - Schrauben für dachbalken - Vis pour fixation pannes de toit - Viti per perline del tetto - Schroef voor gordingen / dakbalken - Kruvi pärlinitele 	6	5x120	
HS18	Screw for gable - Schrauben für giebel - Vis pour fixation des pignons - Viti per timpano - Schroef voor gevelpunt - Kruvi viilude kinnitamiseks 	4	5x120	
SH28	Hammer block - Schlagholz - Calle de frappe - Blocco di legno da usare come cuscinetto quando si usa il martello - Slagklos - Löögiklots 	1		
SFS	Nut for storm protection - Schraubenmutter für sturmleiste - Erou pour latte anti-tempete - Dado x asta protezione vento - Moer voor stormverankering - Mutter tormikinnitusliistule 	8	D6	
NF4	Zn nail for roof - Zn nagel für dachbretter - Pointe pour fixation voliges de toit - Chiodi x perline tetto - Spijker(nagel) voor dakhout - Nael katuselauale 	212	2x50	

Pos	18.12.2017	Piece list - Stückliste - Liste des pièces - Elementi - Stuklijst - Tükitalbel 1494x1850 TUK.2.056.SVP.MX28 SGA+28	1/2	Q	P (mm)	L (mm)
		Glass size - Glasgröße - Taille de la vitre - Misura del vetro - Glas afmeting - Klaasi mõõt: 502x750 mm				
						 1418x1794 mm
						
1	Upper door jamb - Türrahmen oben - Cadre de porte supérieur - Telaio superiore della porta - Bovendorpel - Ukse ülemine leng		1	66x100	1628	
2	Left door jamb - Türrahmen links - Cadre de porte gauche - Telaio montante sinistro della porta - Linkerstijl deurframe - Ukse vasak leng		1	66x80	1850	
3	Right door jamb - Türrahmen rechts - Cadre de porte droit - Telaio montante destro della porta - Rechterstijl deurframe - Ukse parem leng		1	66x80	1850	
4	Doorstep - Swelle - Barre de seuil - Soglia della porta - Deurdorpel - Lävepak		1	18x18	1418	
5	Connection strip - Deckleiste - Baguette de battement - Profilo verticale della porta - Stulpilist - kokkuvaltsiliist		1	13x32	1812	
6	Georgian bars - Sprossen - Croisillons - La griglia georgiana - Raamverdeling - Petteliistud		2	15x25	784	
7	Georgian bars - Sprossen - Croisillons - La griglia georgiana - Raamverdeling - Petteliistud		4	15x25	536	

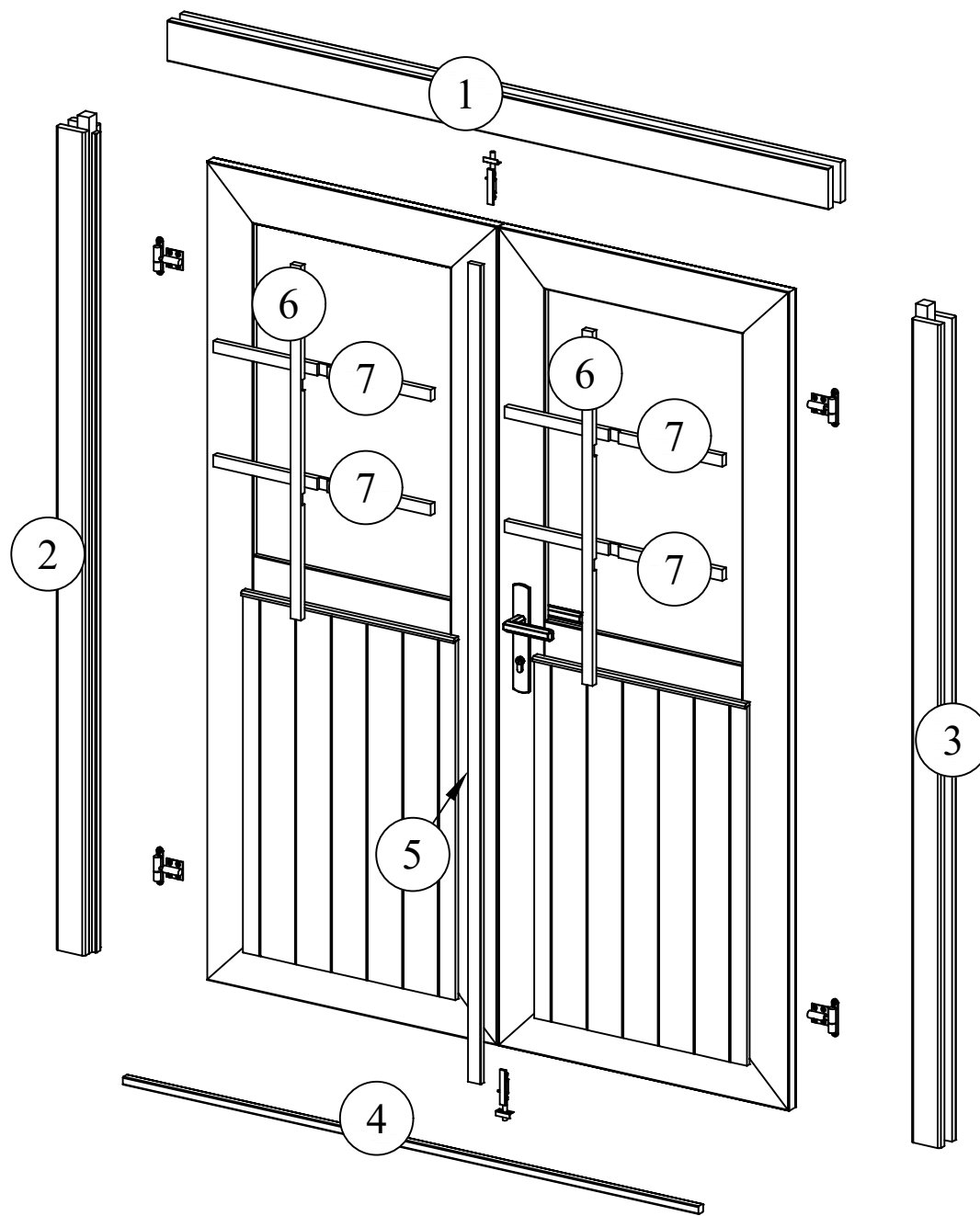

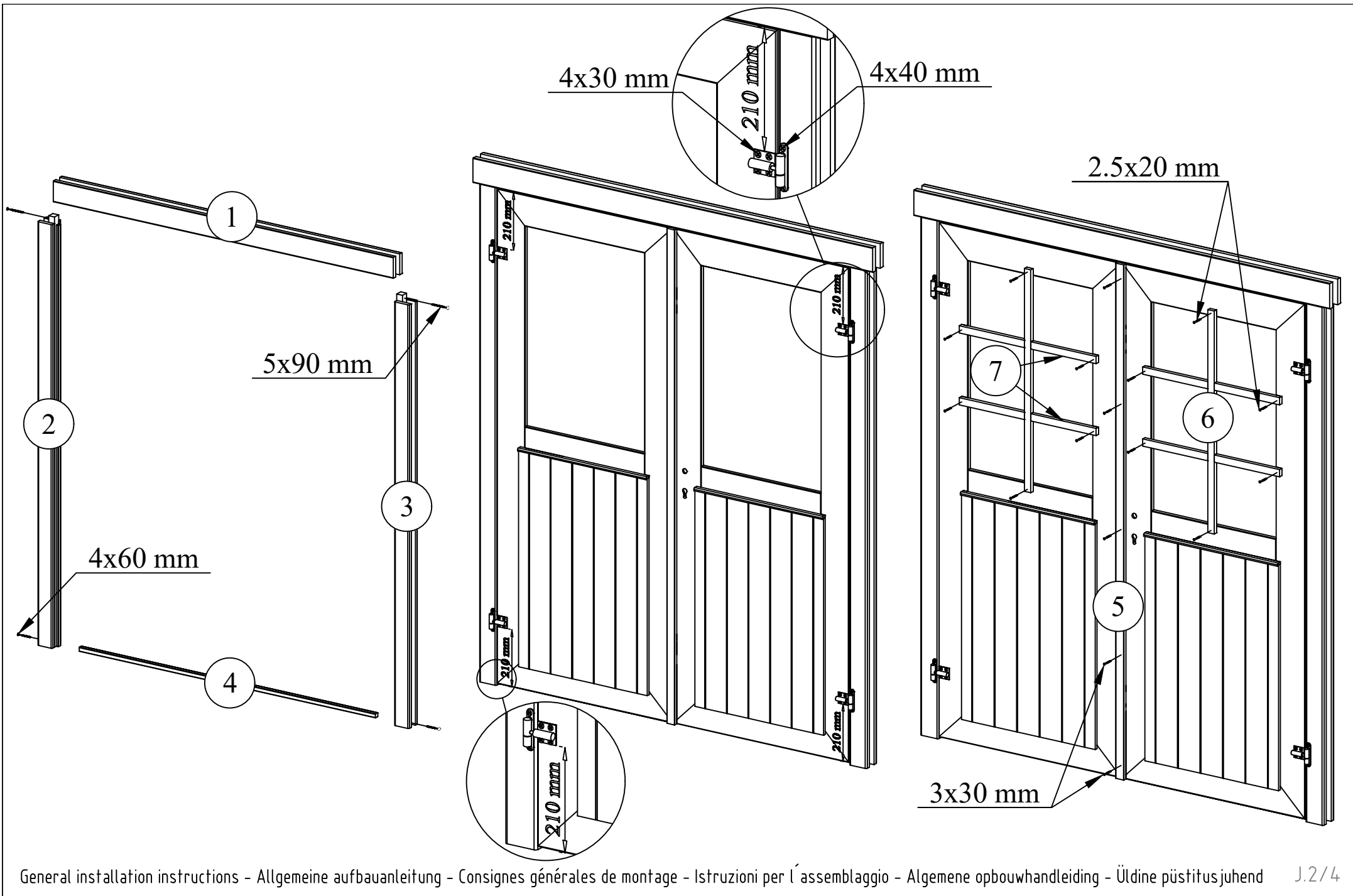

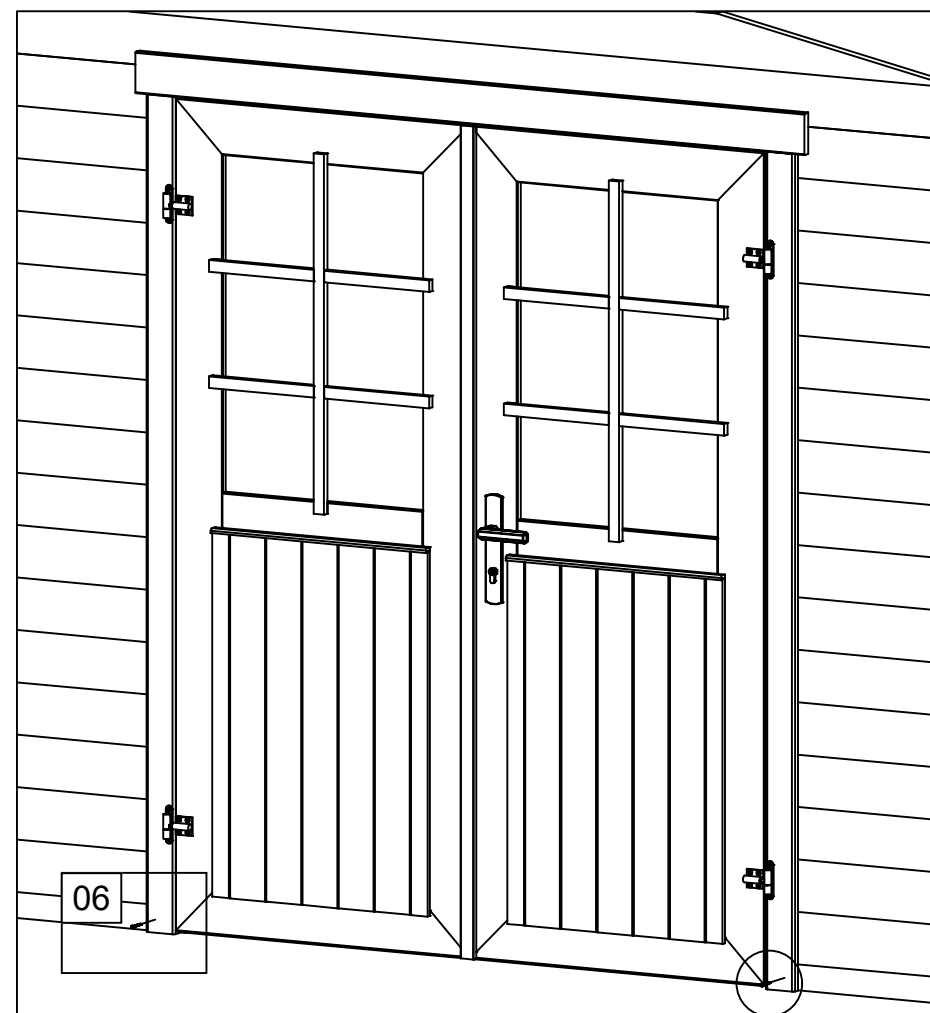
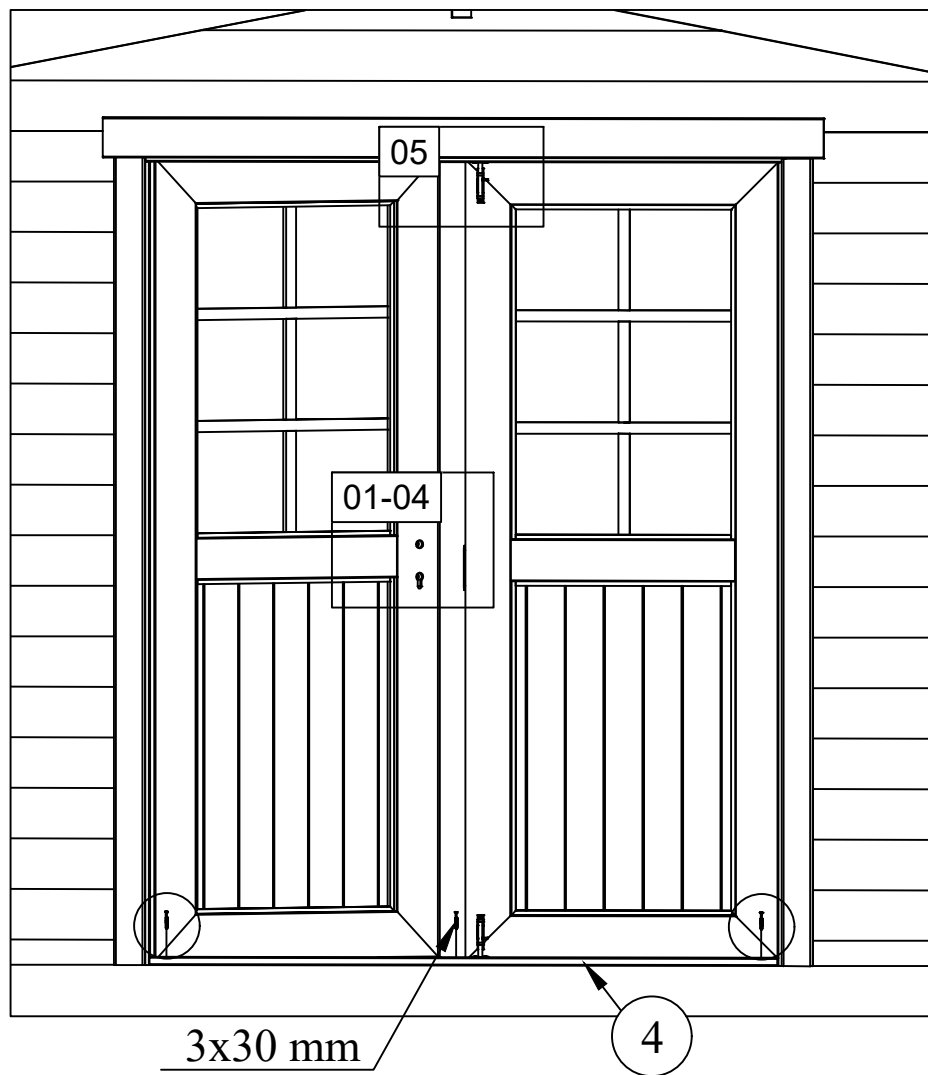

01



04



02



05



03



06

