

Karlskrona mit Anbau

Art. Nr. 4021659

1/21

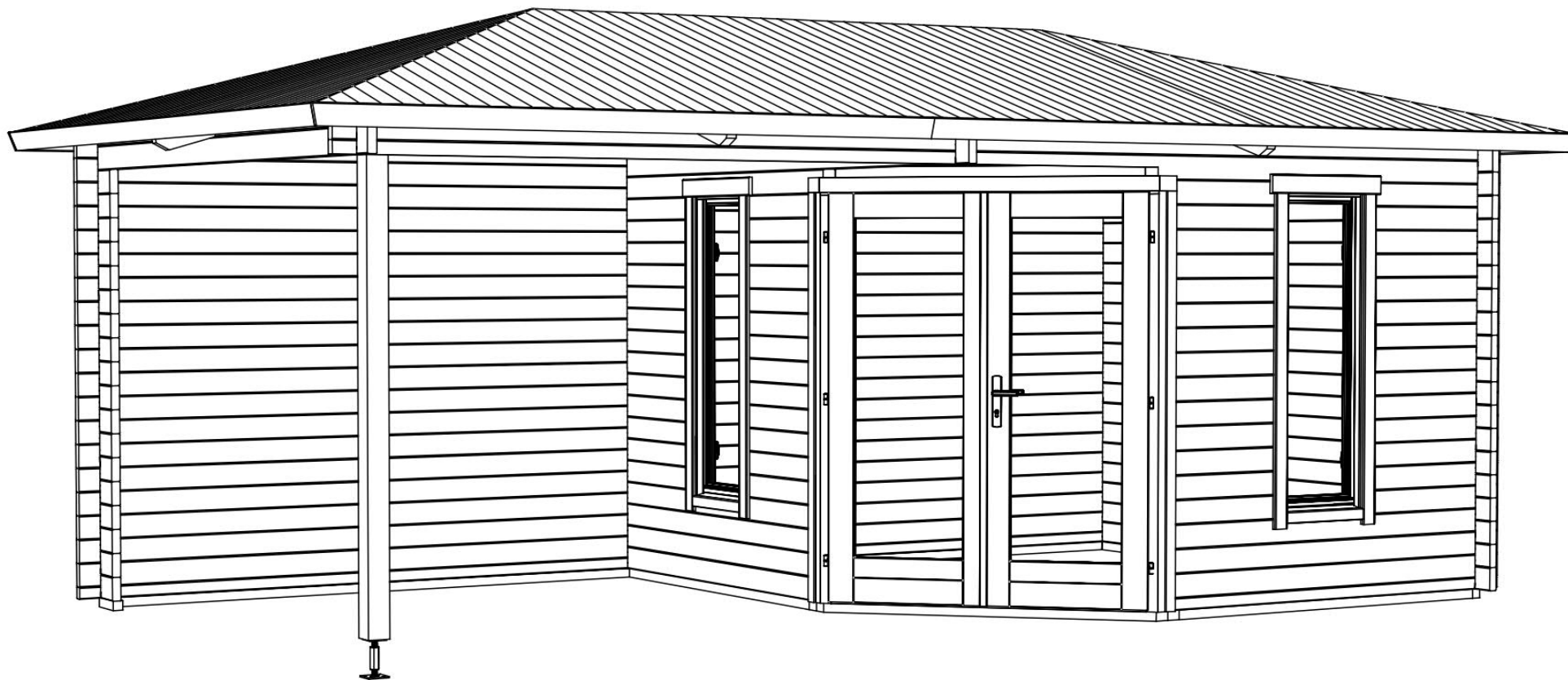

21.09.2020

Art. Nr. 4021659

Groundplan - Grundplan - Plan de masse - Planimetria - Plattegrond- Põhiplaan

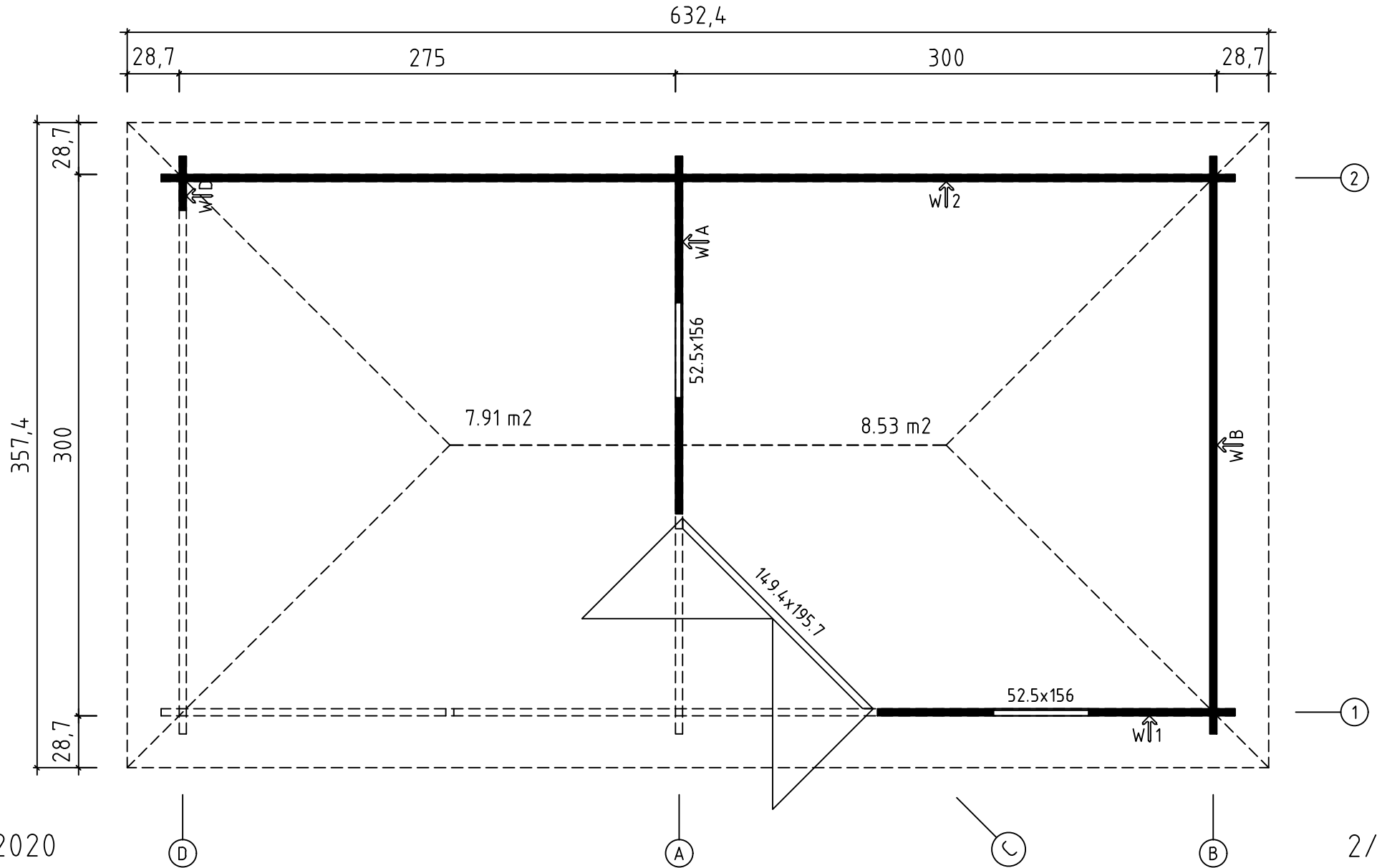

21.09.2020

2/21

Art. Nr. 4021659

Foundation - Fundament - Fondazione - Fondamenta - Fundering - Immutatud alusraam

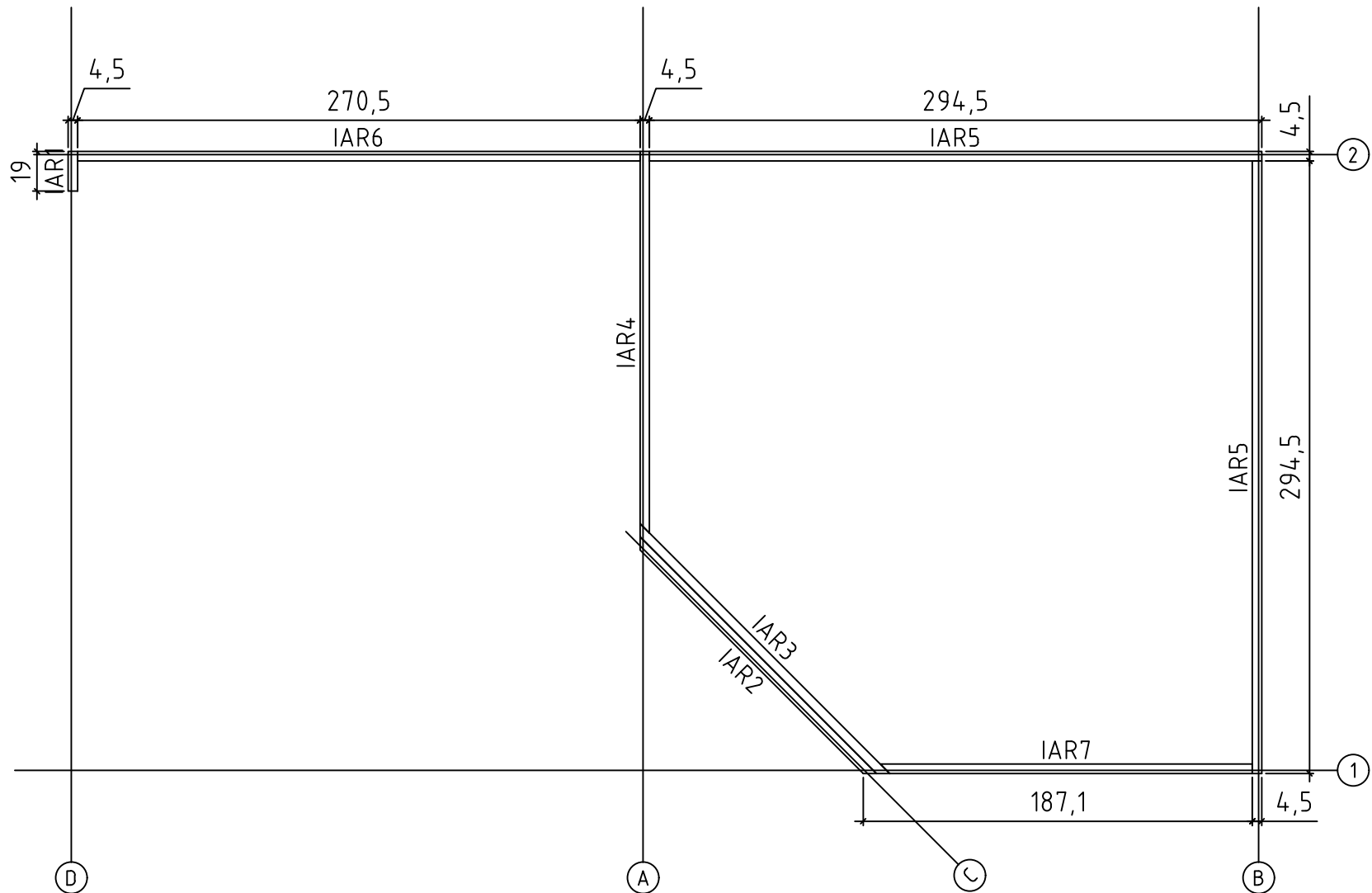

Art. Nr. 4021659

Diagonals must be equal - Prüfung diagonale Austrichtung $A=B$; $C=D$ - Controle des diagonales $A=B$; $C=D$ -
Le diagonali devono essere eguali - Gelijkbenige diagonaal - Diagonaalid peavad olema võrdsed $A=B$; $C=D$

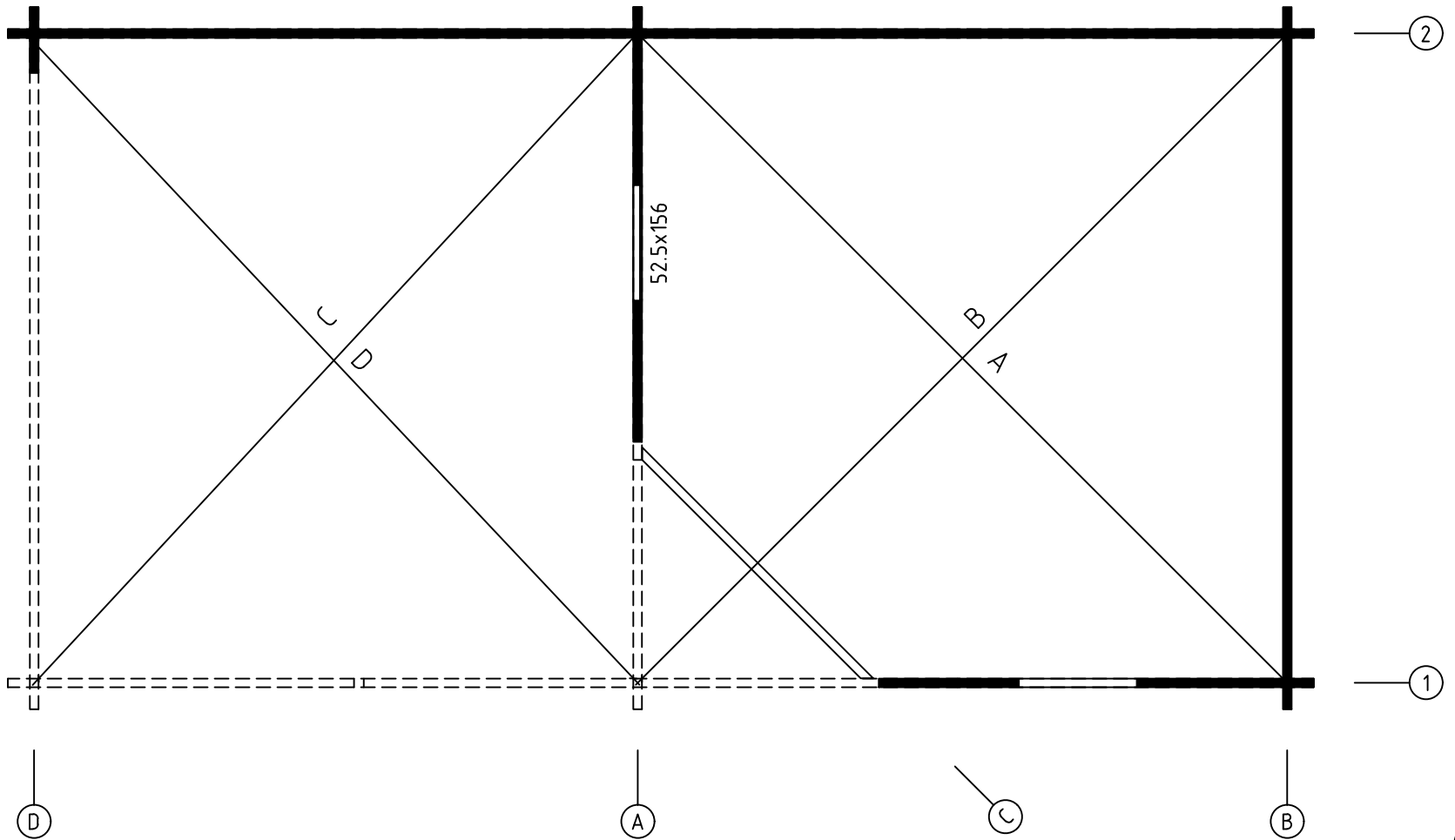

Art. Nr. 4021659

Overhead beams - Deckenbalken - Solives - Travi a vista -
Overlopende balken - Laetalade konstruksioon

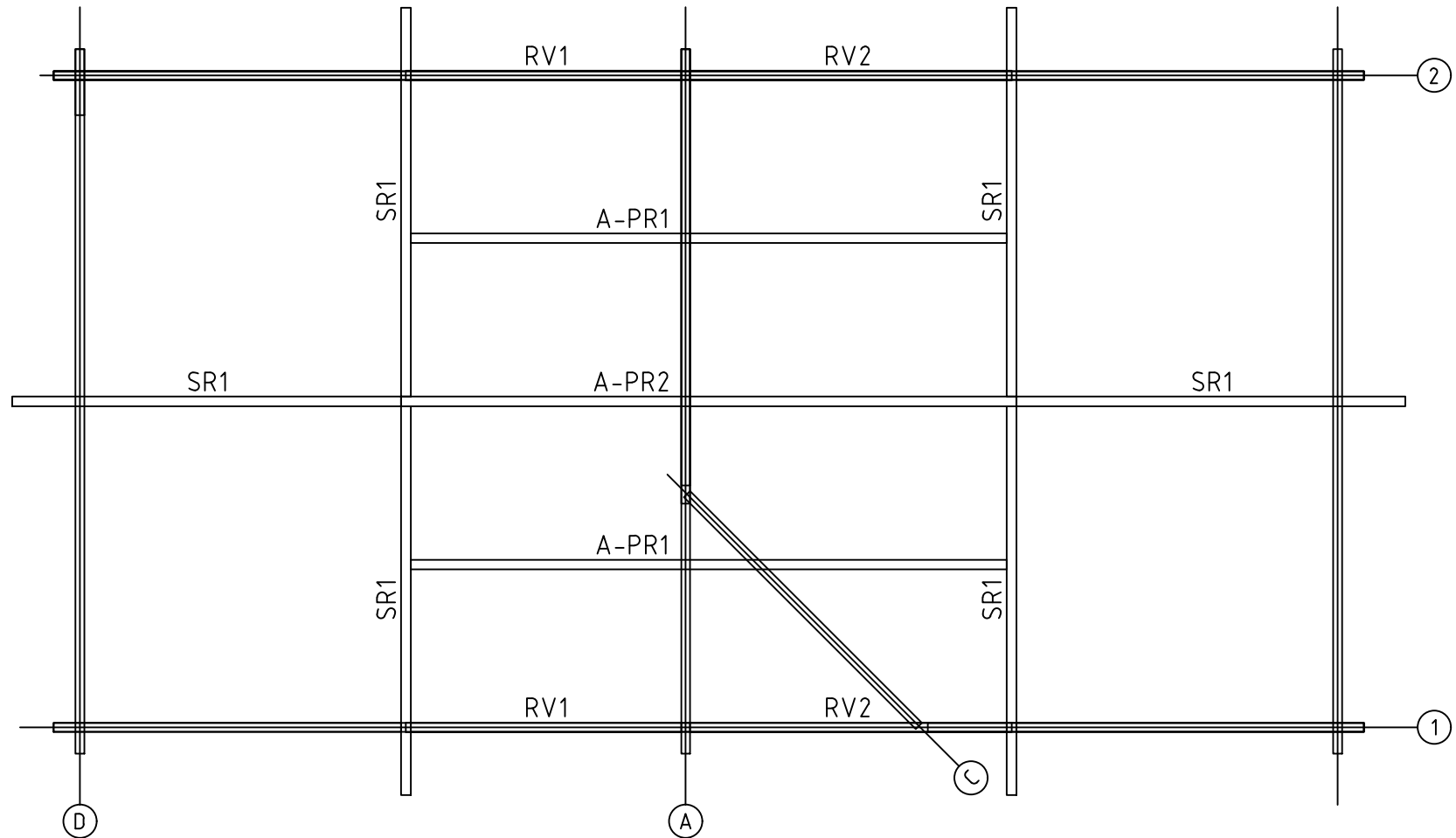

21.09.2020

5/21

Art. Nr. 4021659

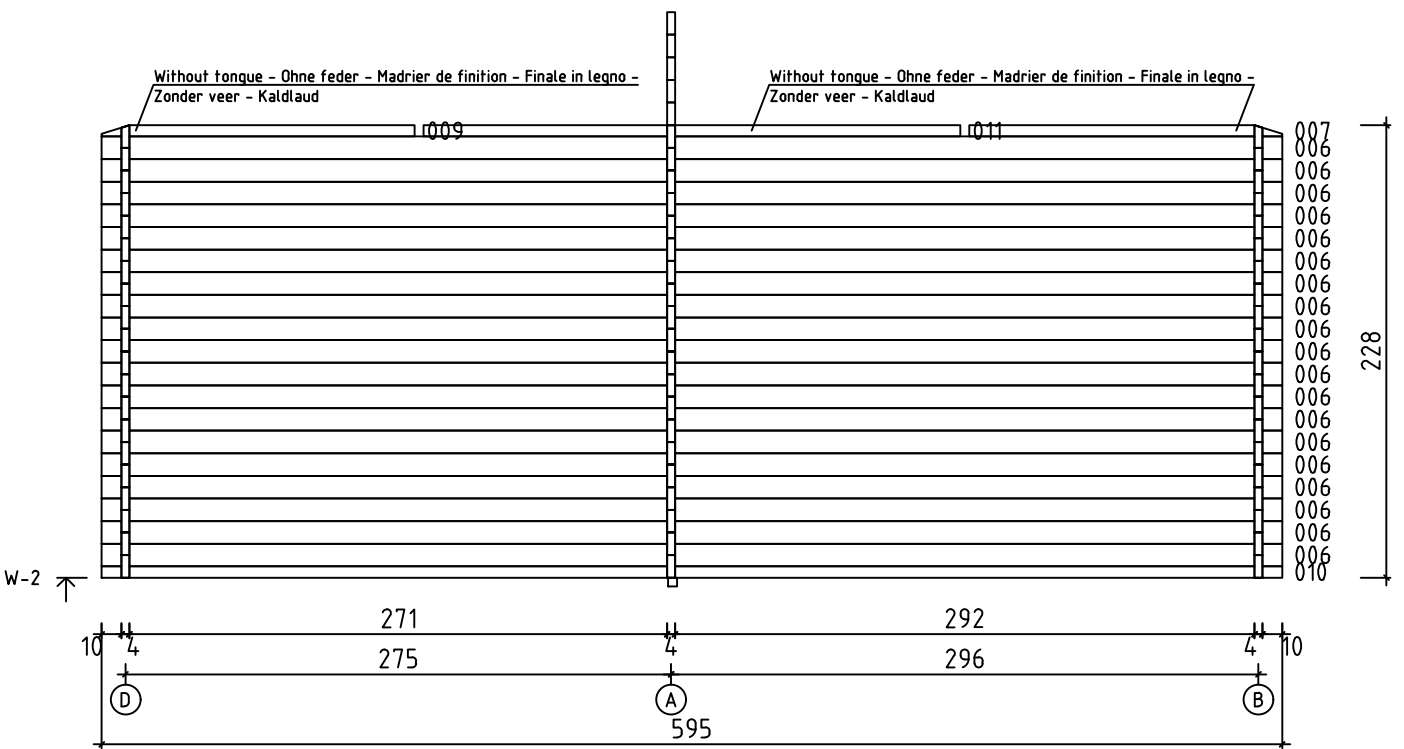
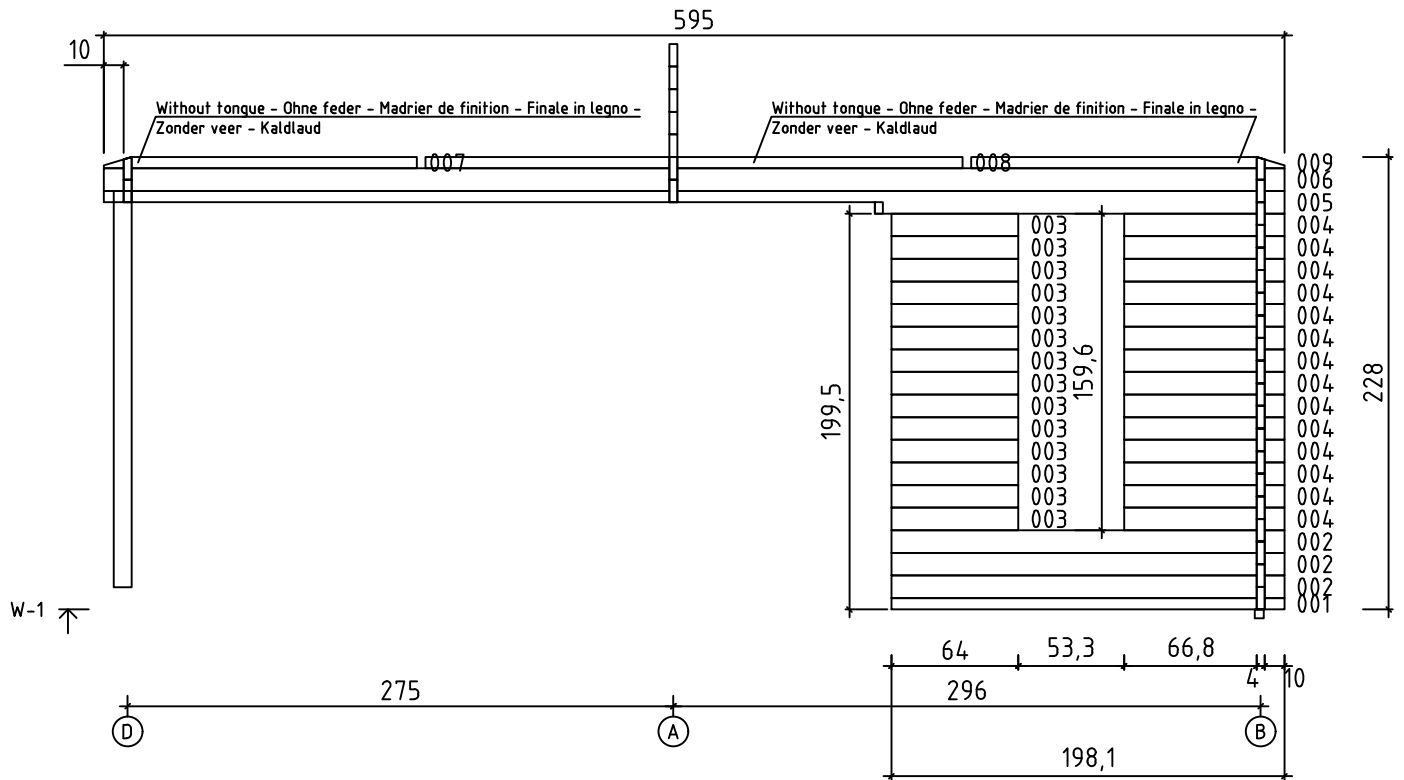

Art. Nr. 4021659

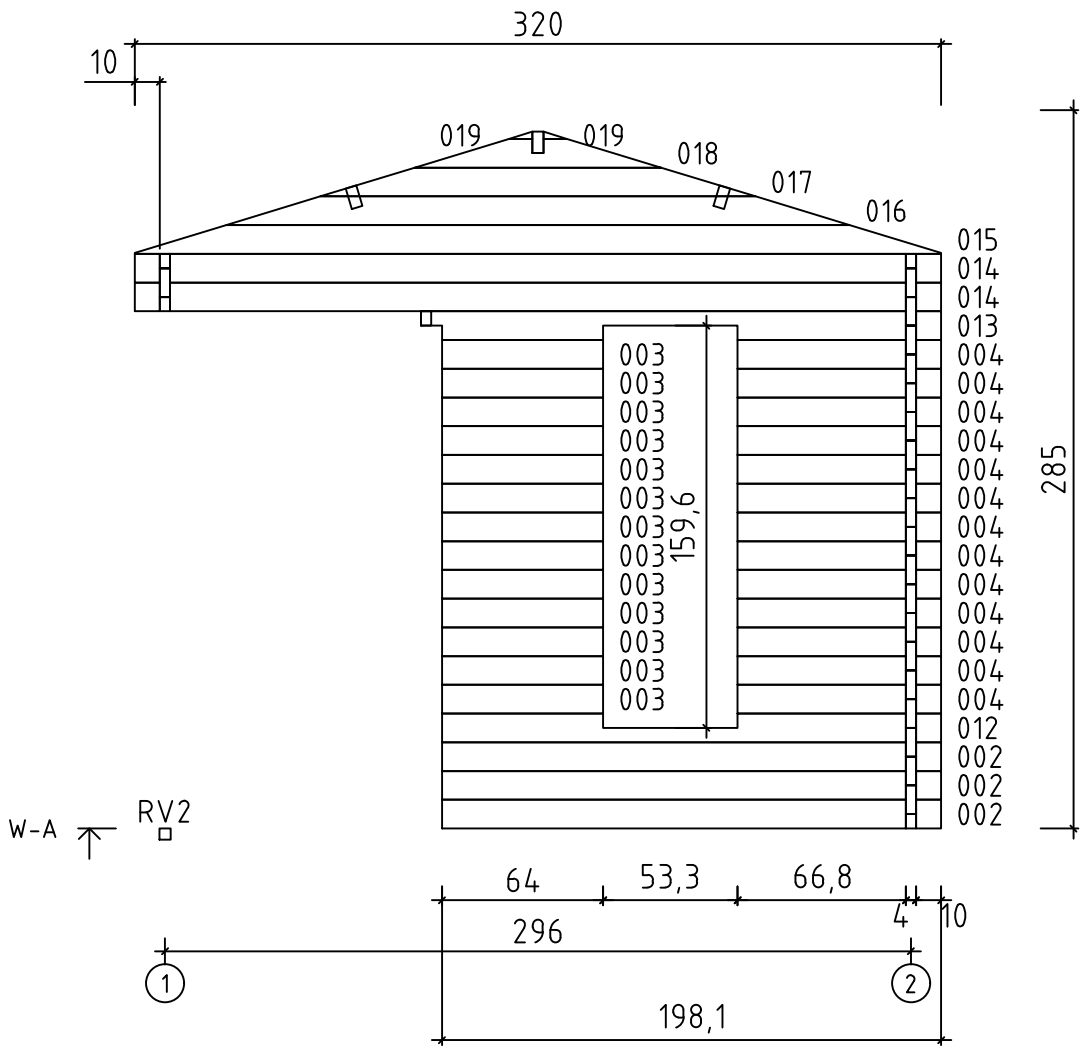

Without tongue - Ohne feder - Madrier de finition - Finale in legno - Zonder veer - Kaldlaud

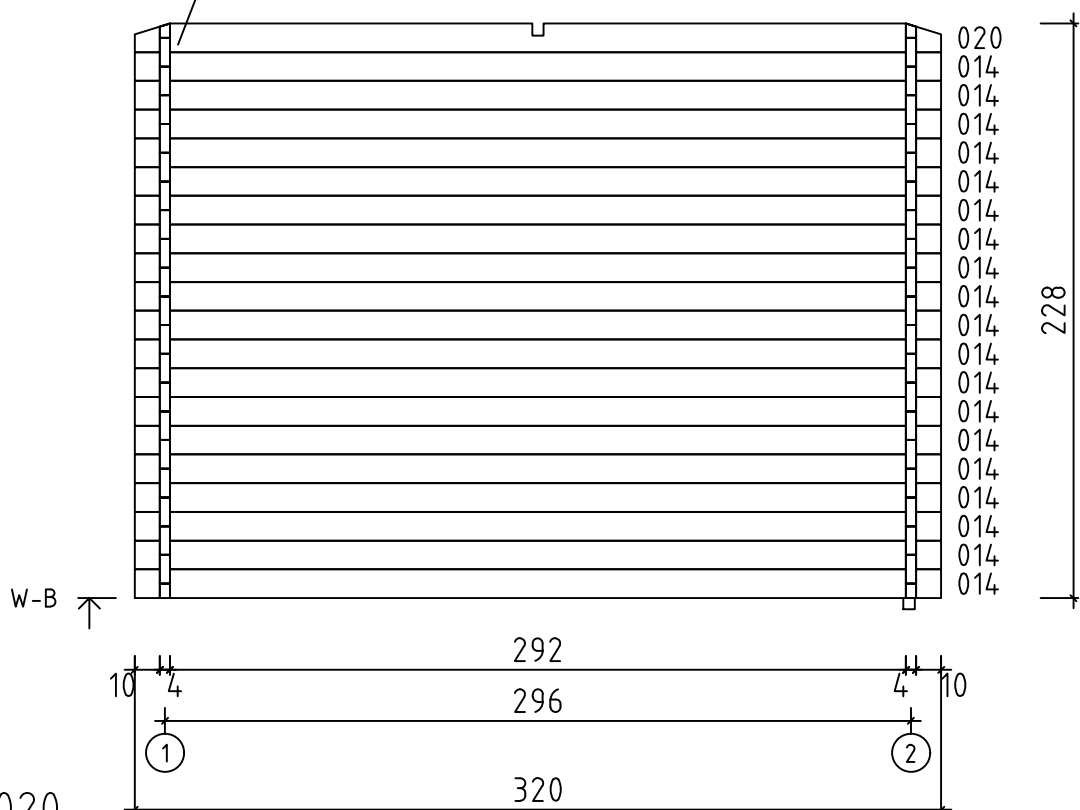

21.09.2020

7/21

Art. Nr. 4021659

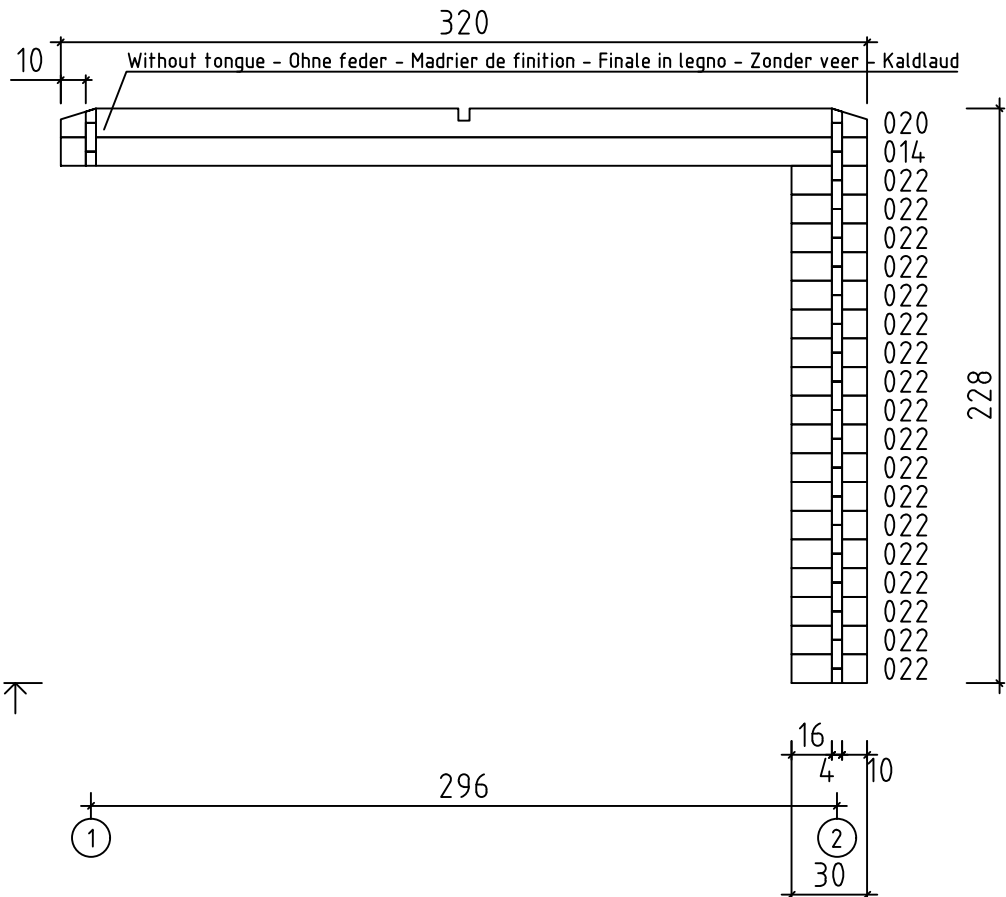
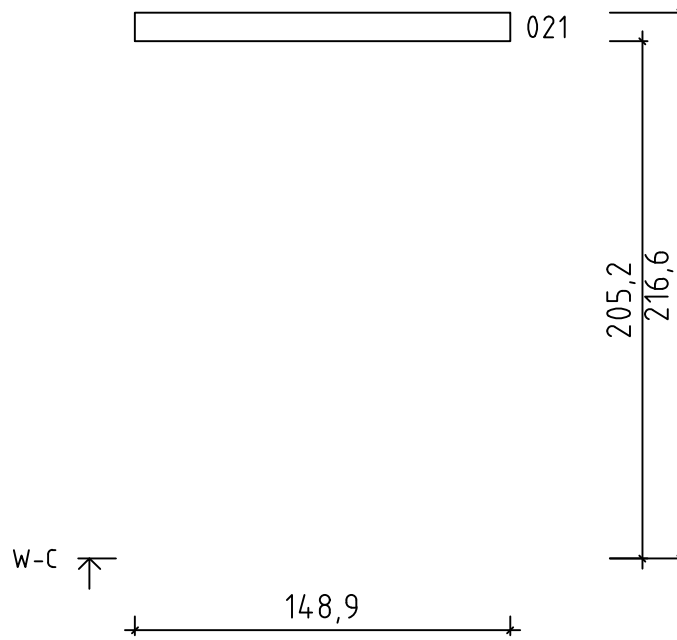

A

Art. Nr. 4021659

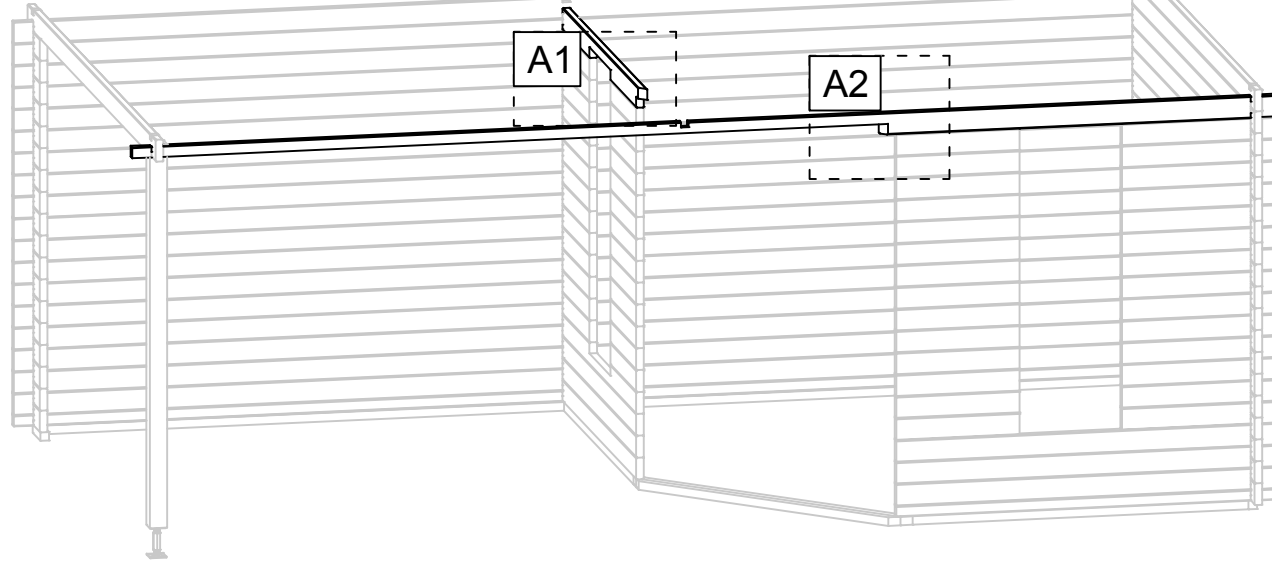

A1

005a

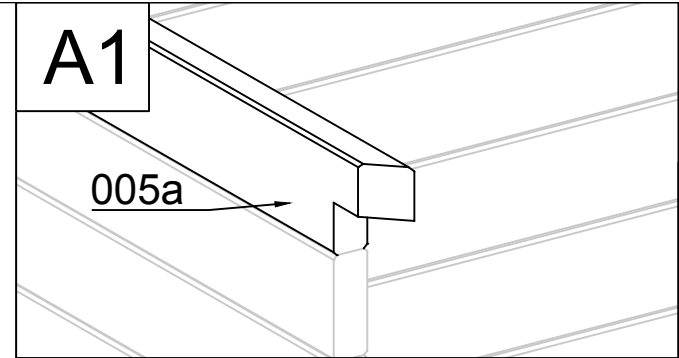

A2

013a

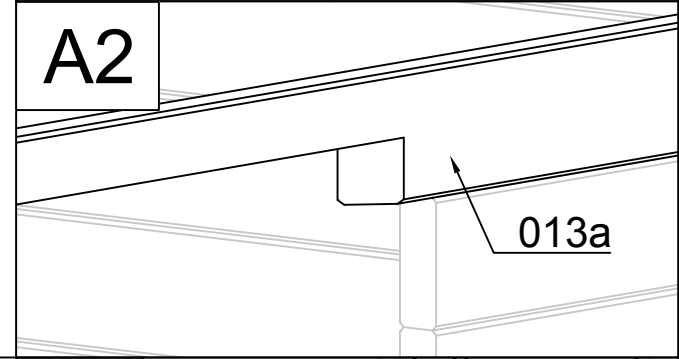

B

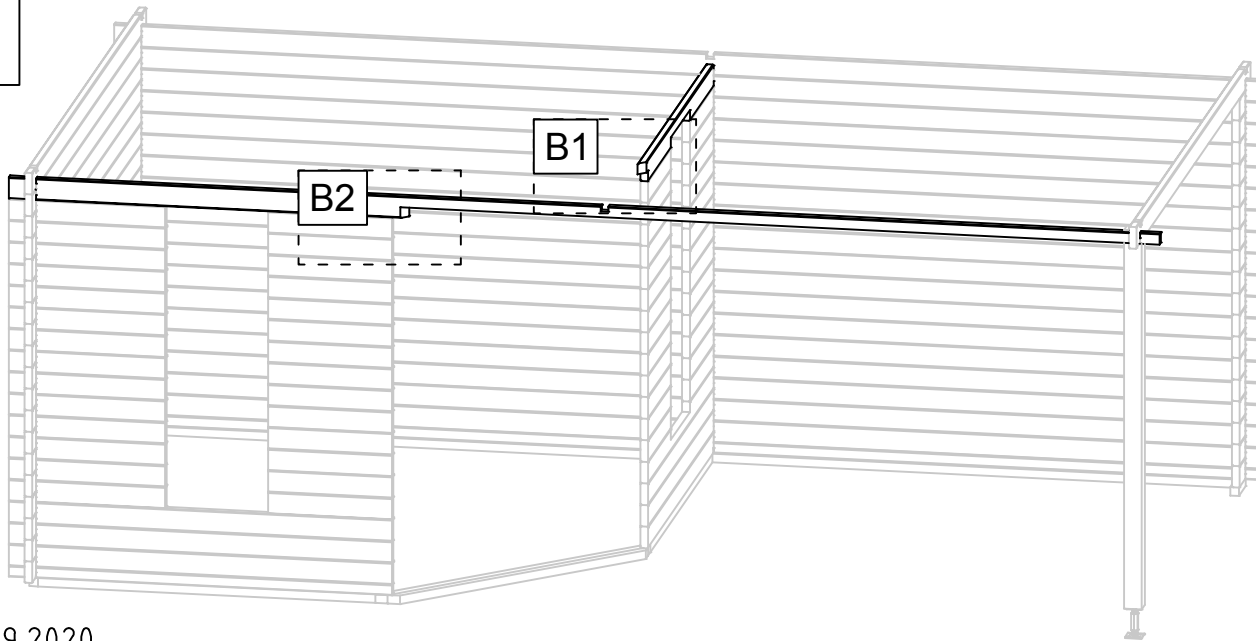

B1

005b

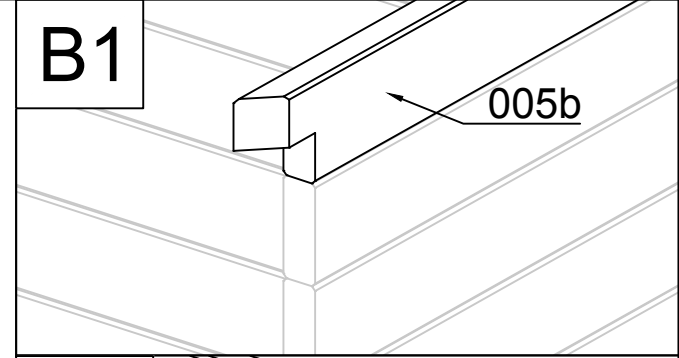

B2

013b

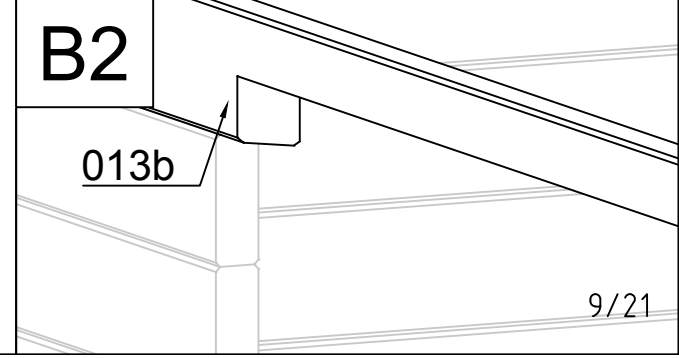

Art. Nr. 4021659

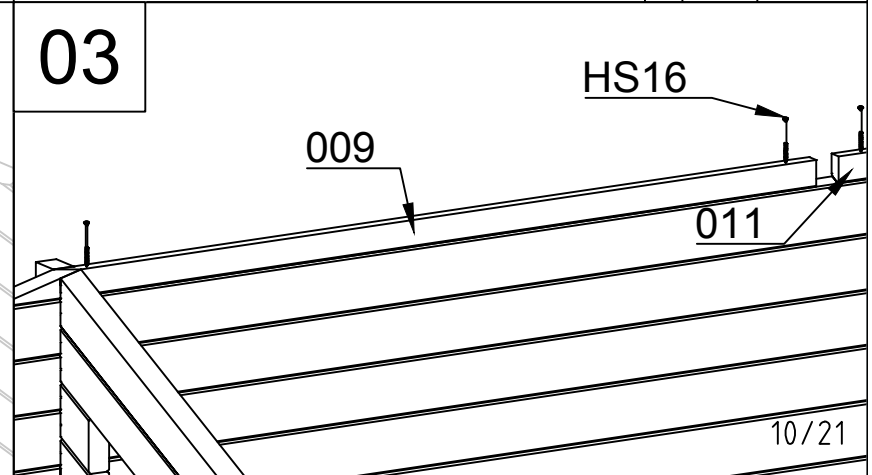
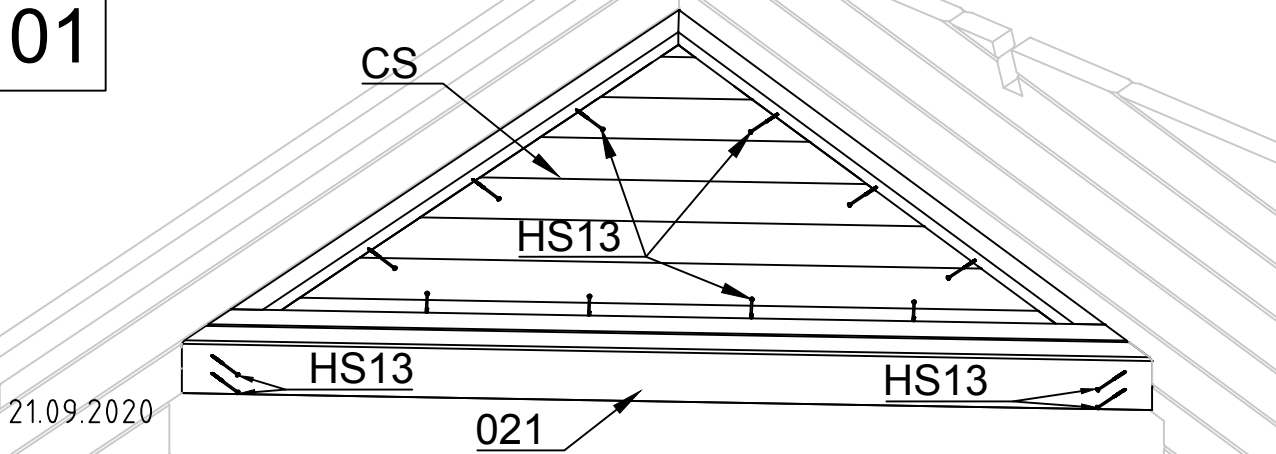
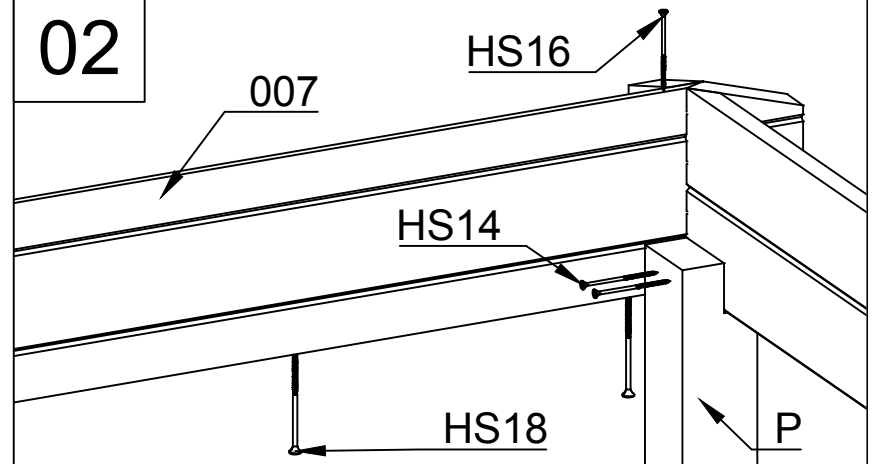
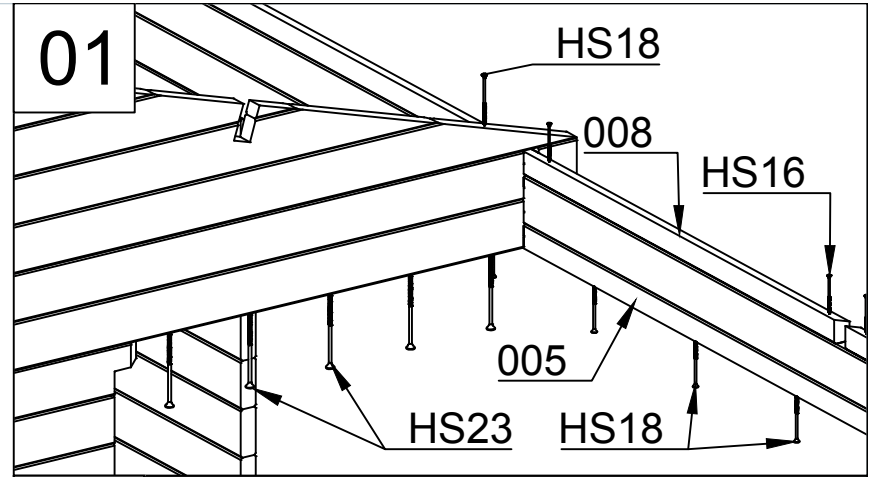
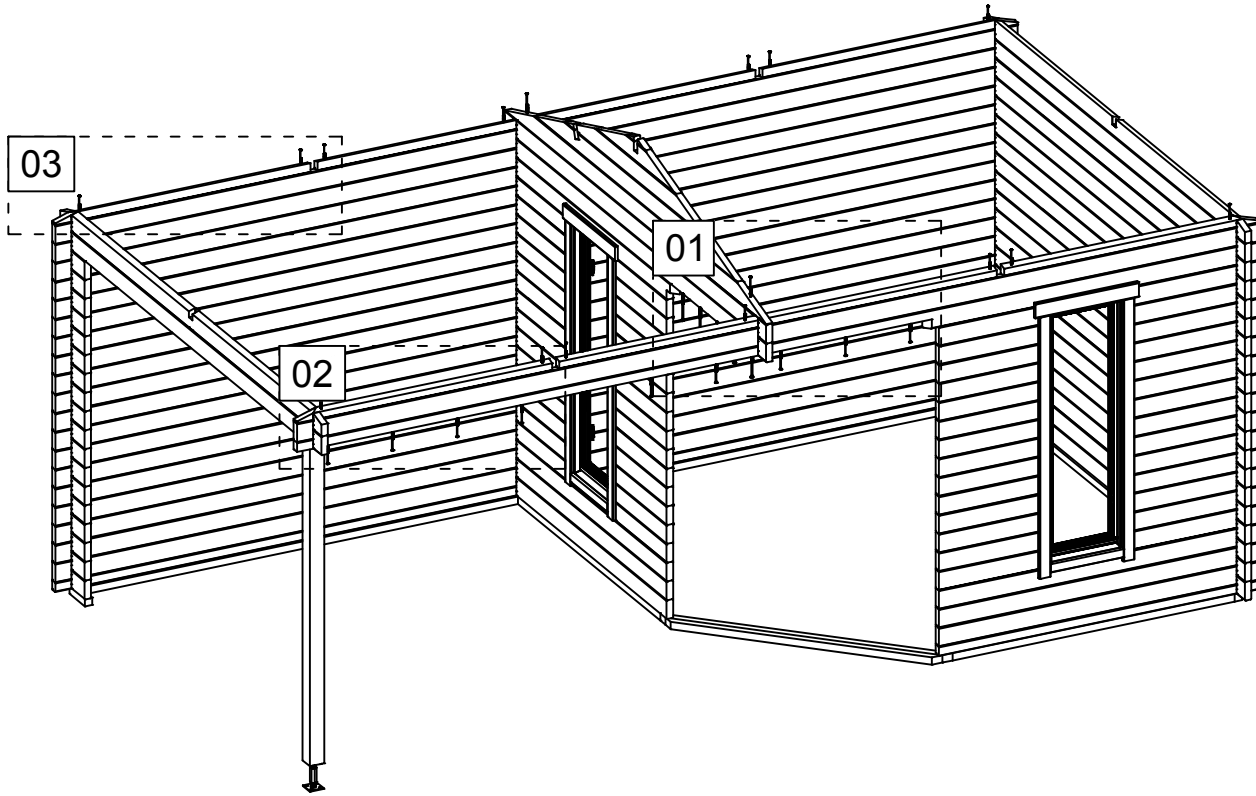

21.09.2020

10/21

Art. Nr. 4021659

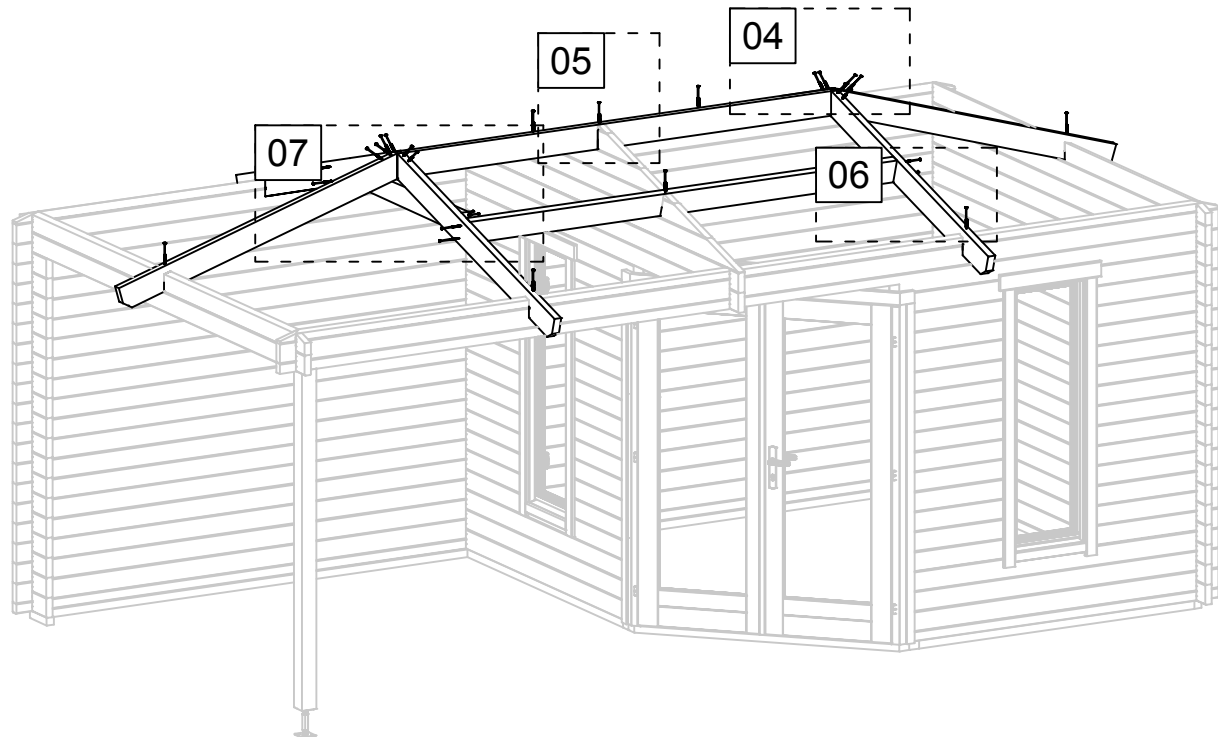

04

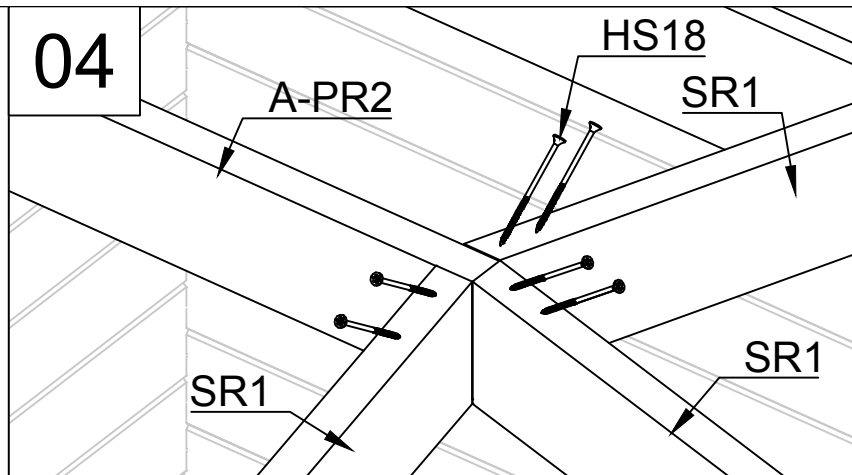

05

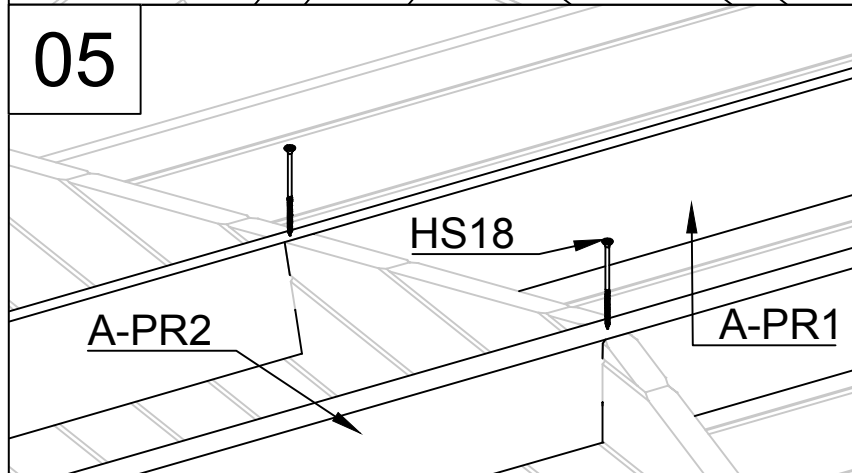

07

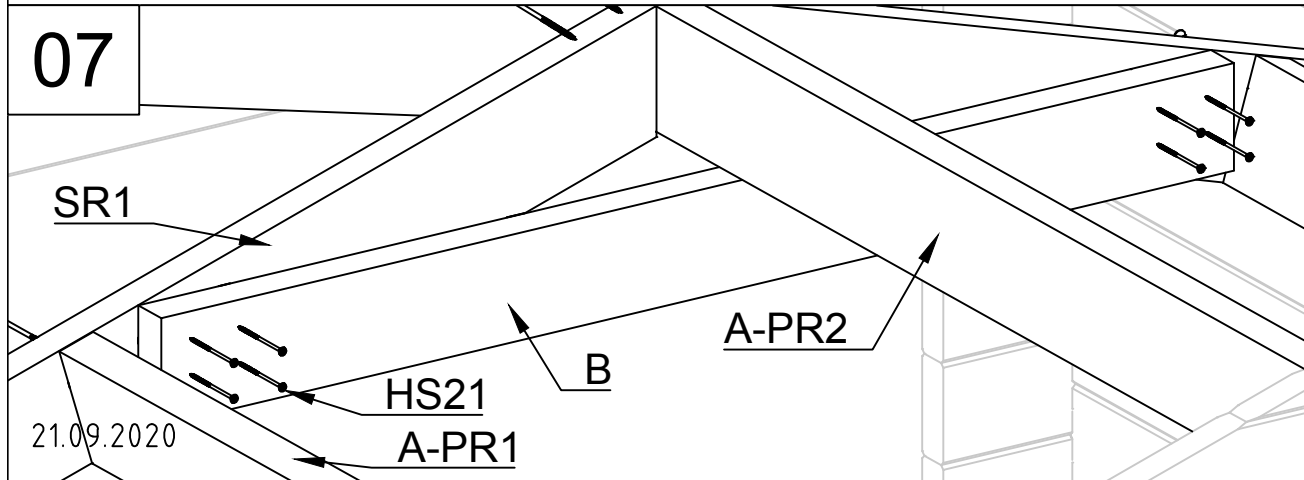

21.09.2020

06

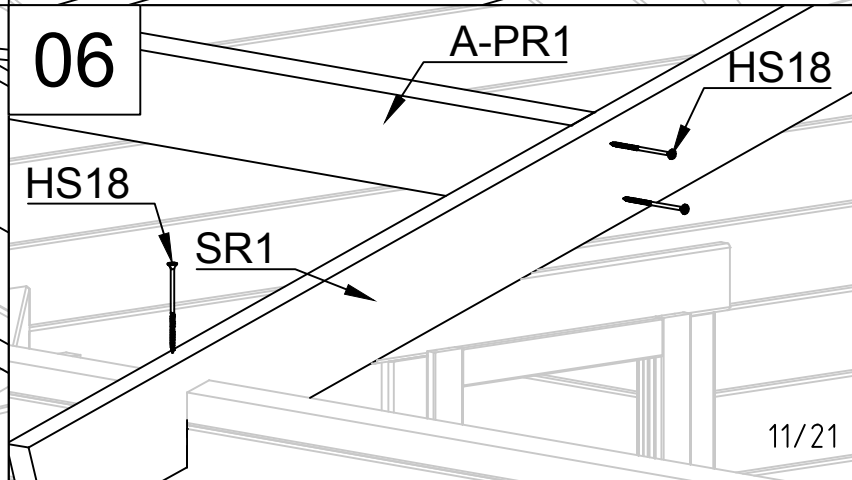

11/21

Art. Nr. 4021659

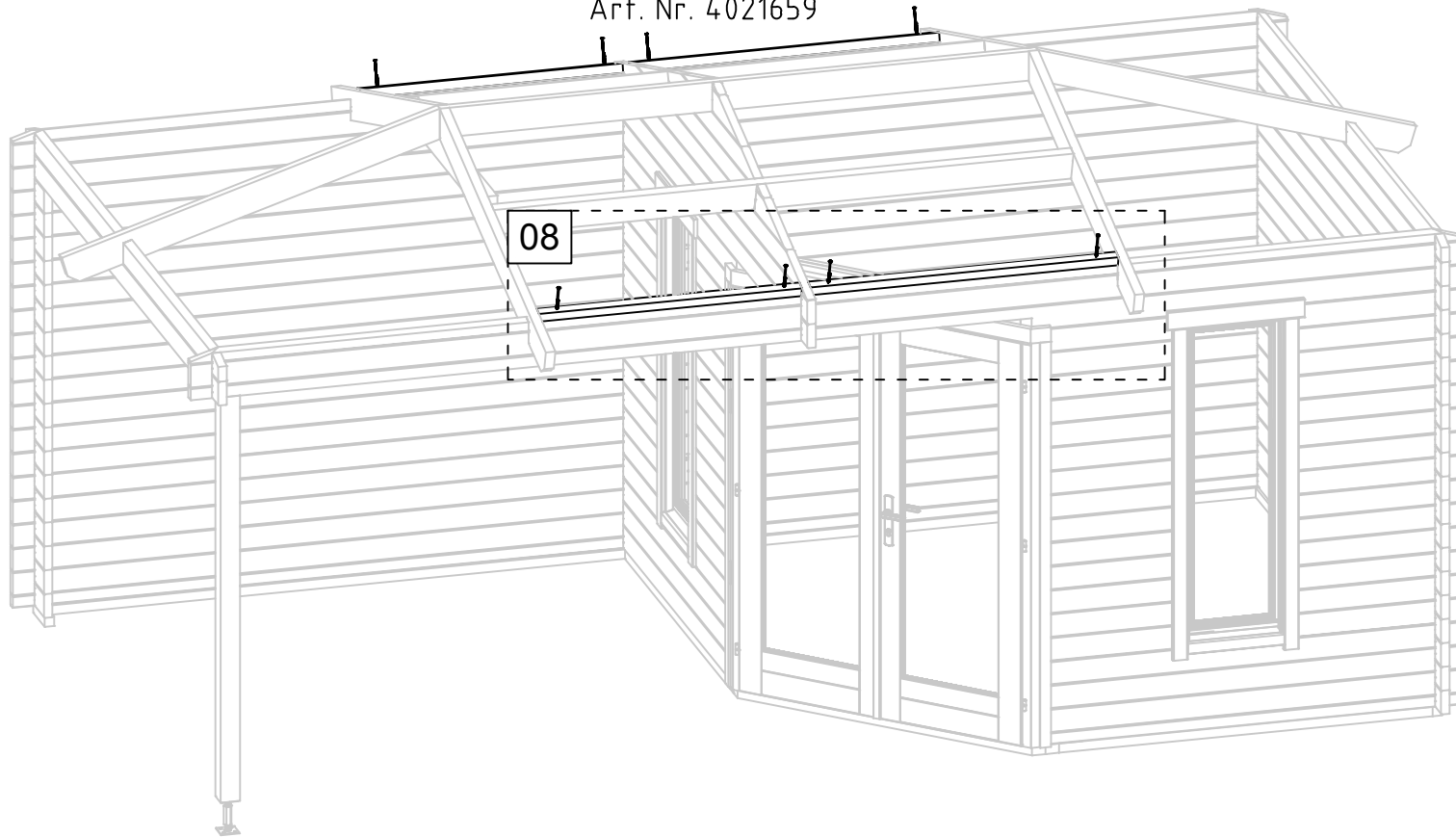

08

HS16

RV1

RV2

HS16

21.09.2020

12/21

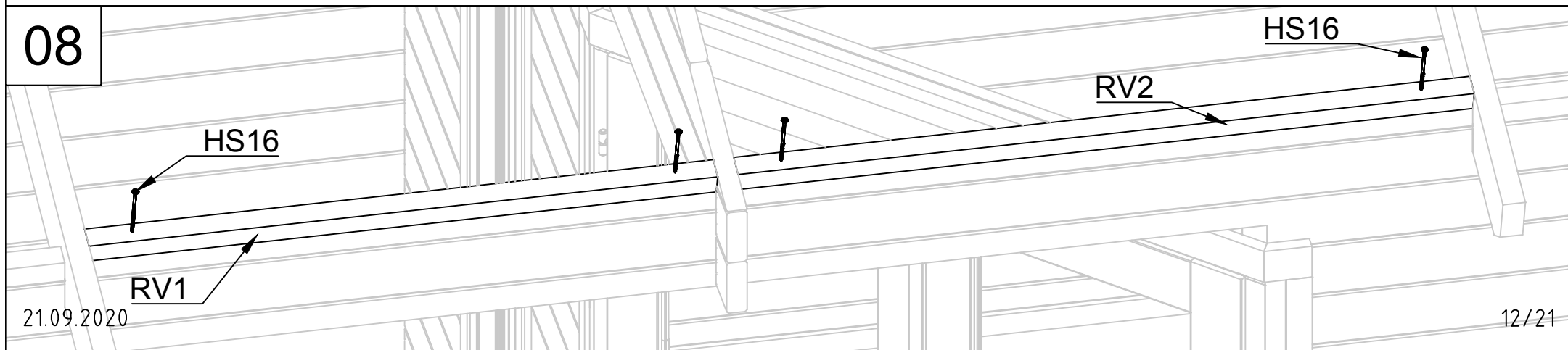

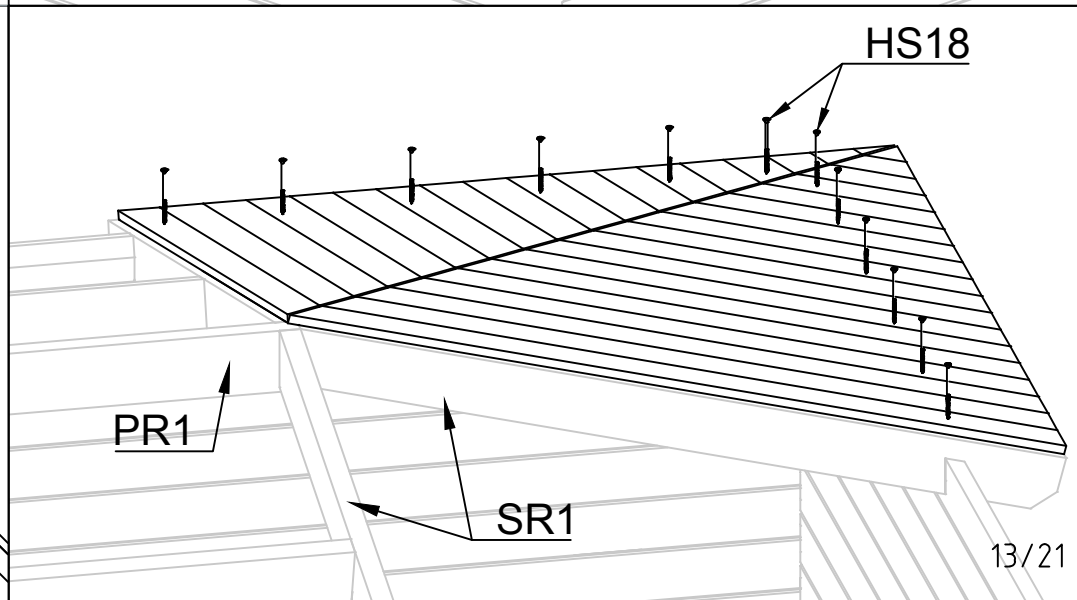
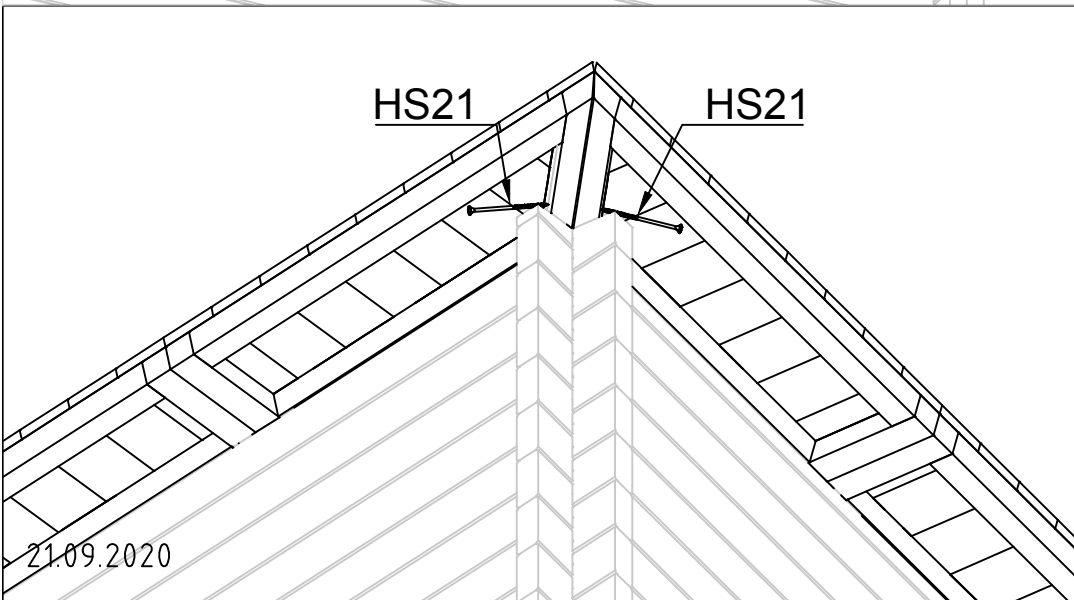
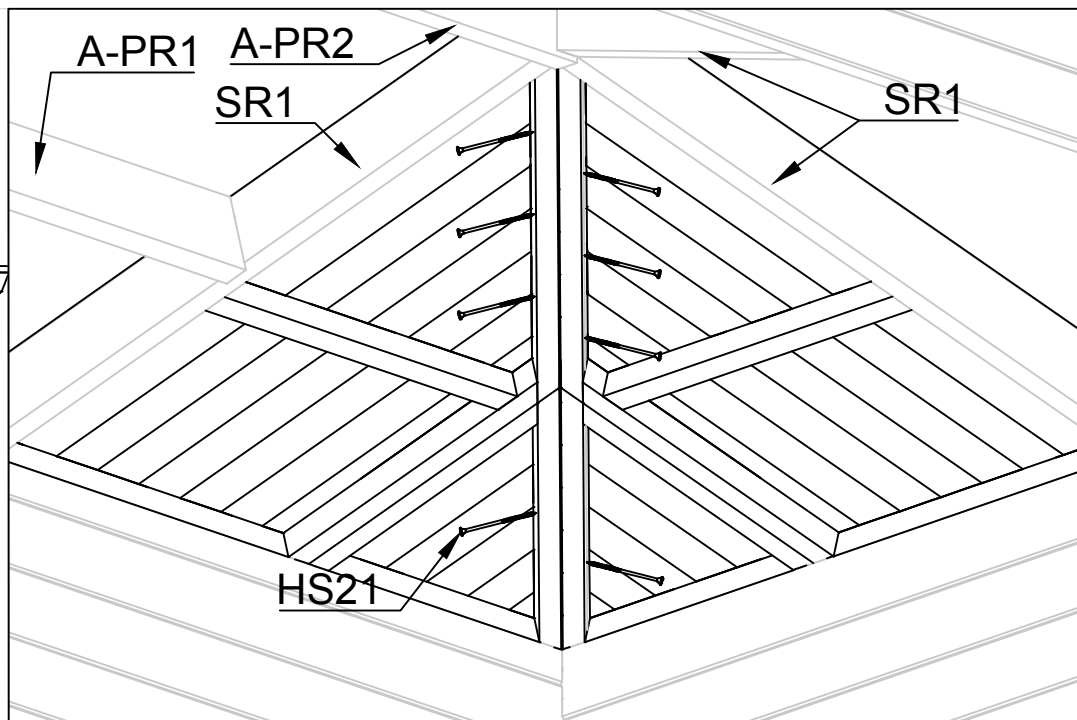
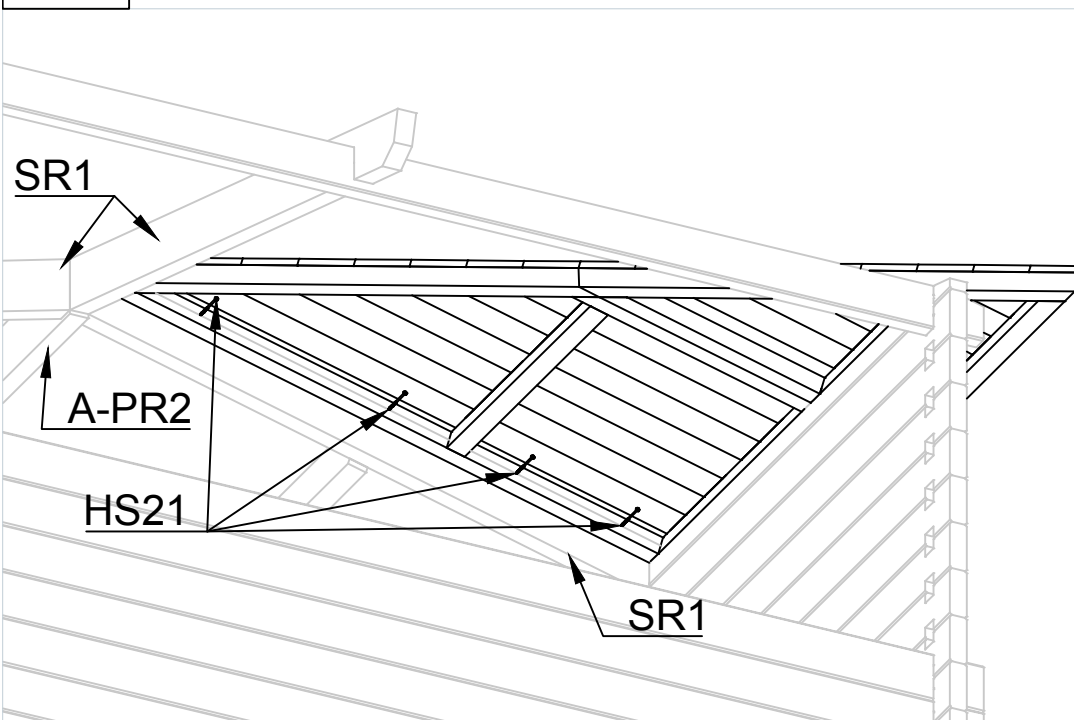

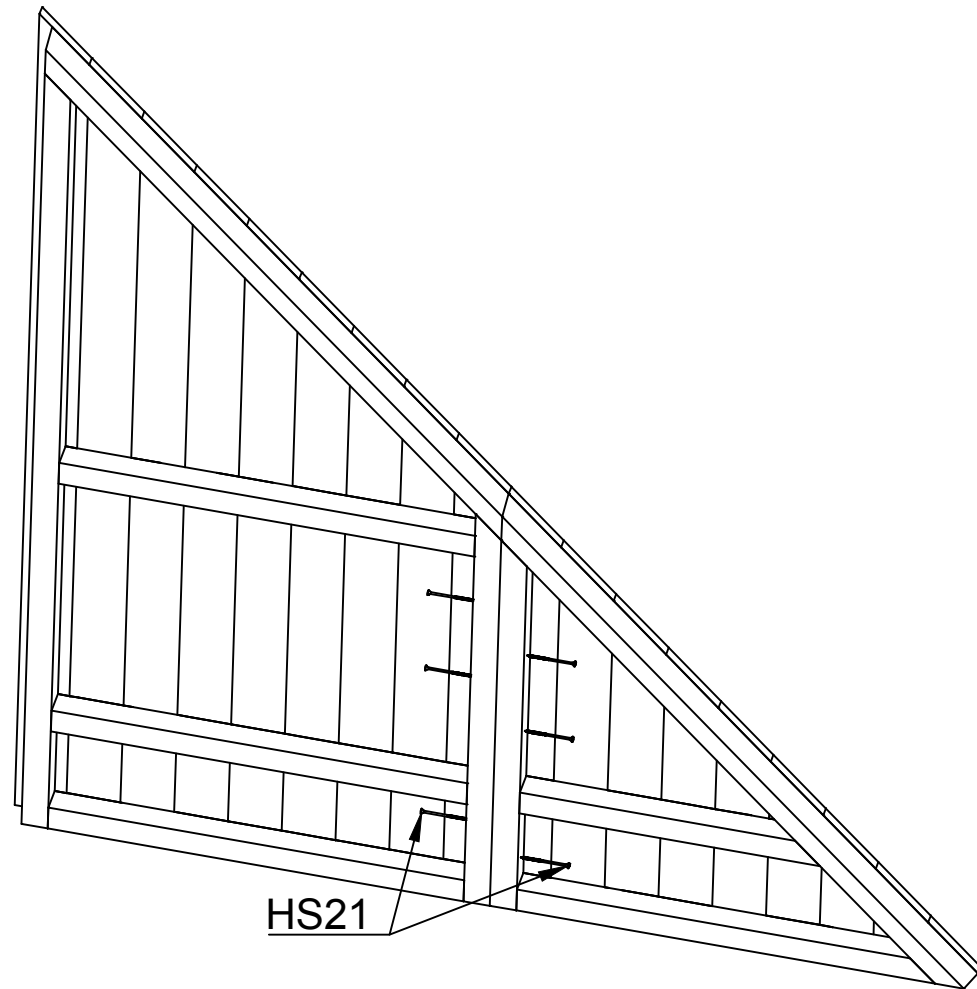
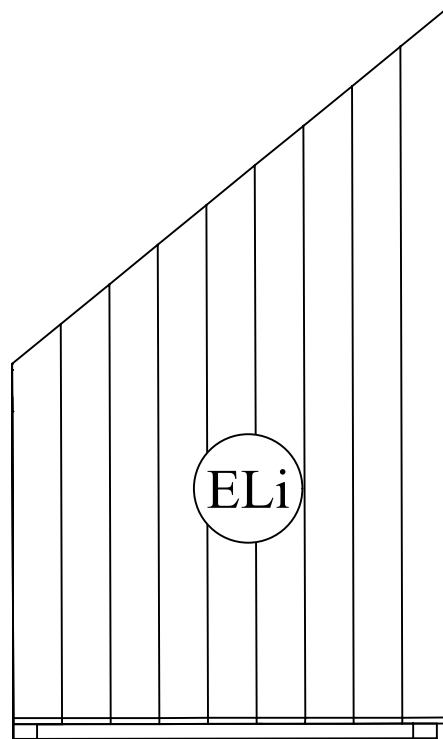
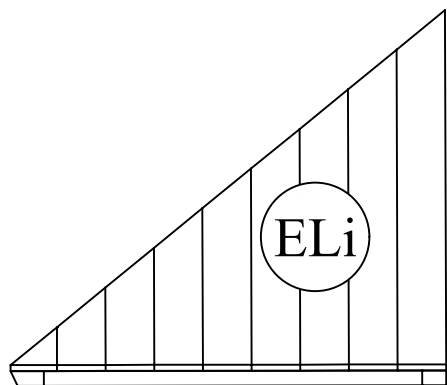

Art. Nr. 4021659

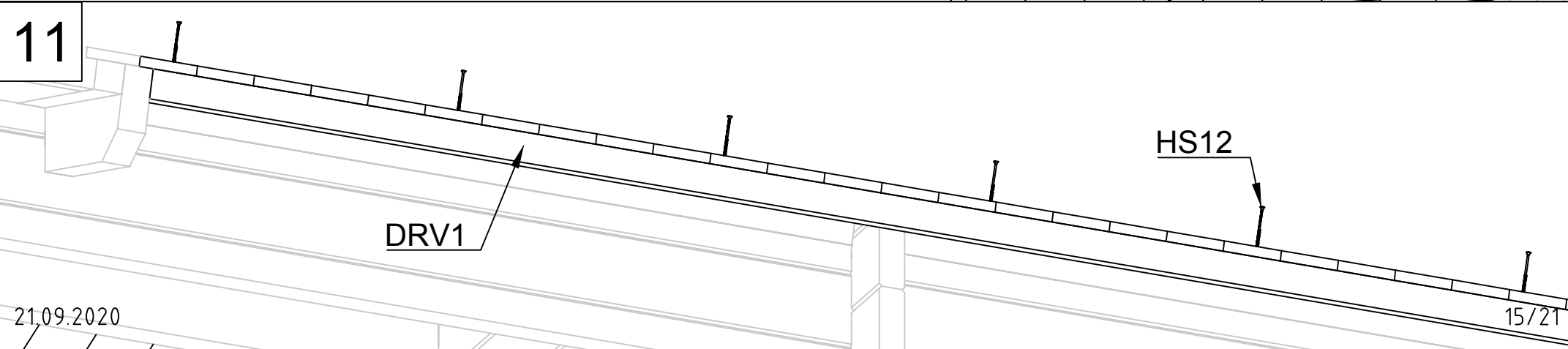
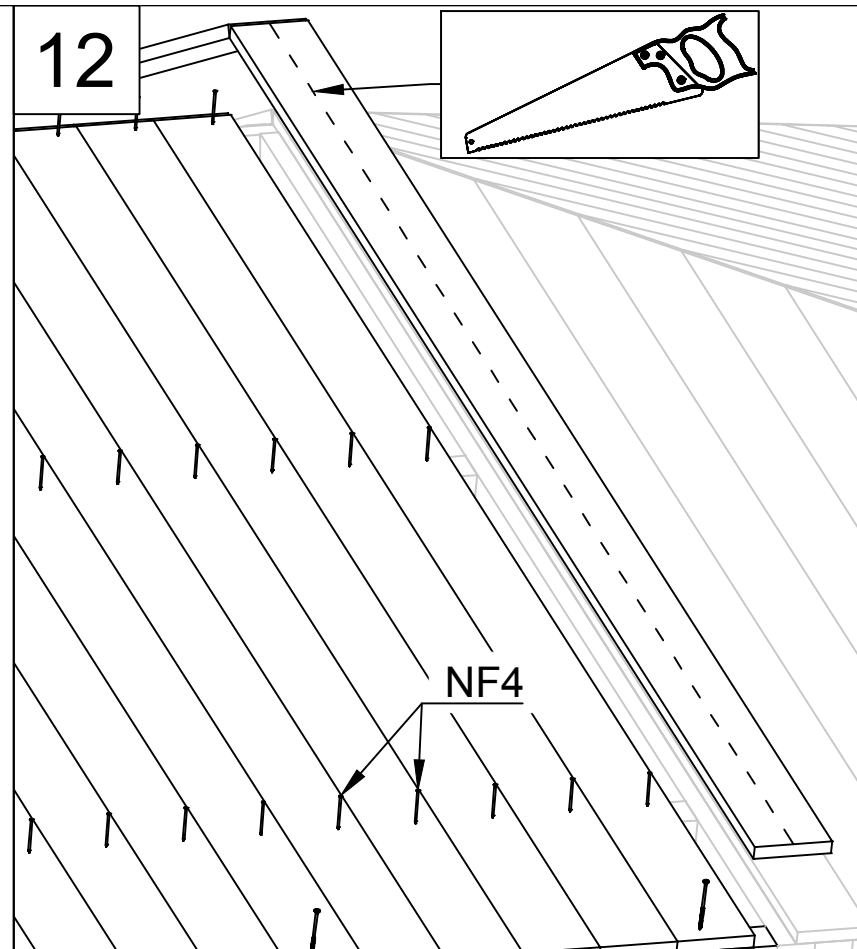
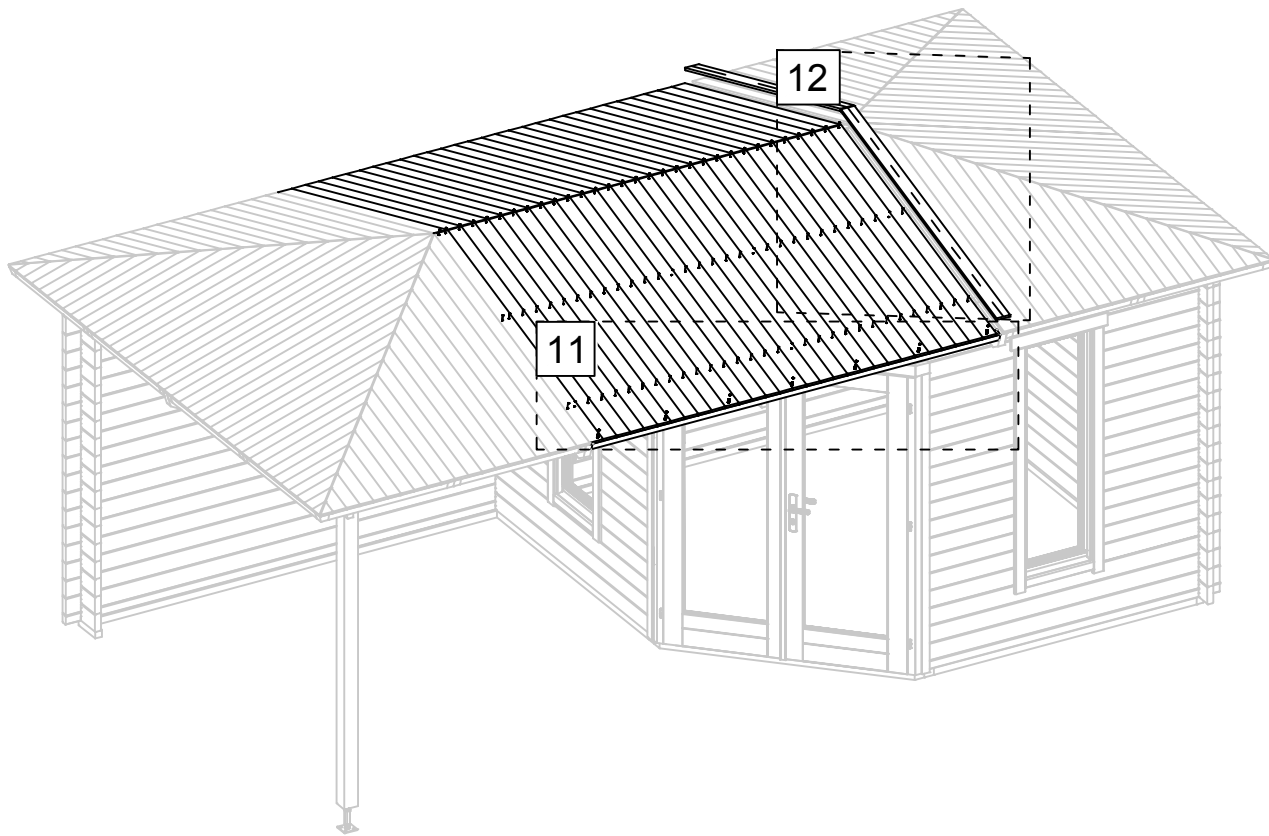

Art. Nr. 4021659

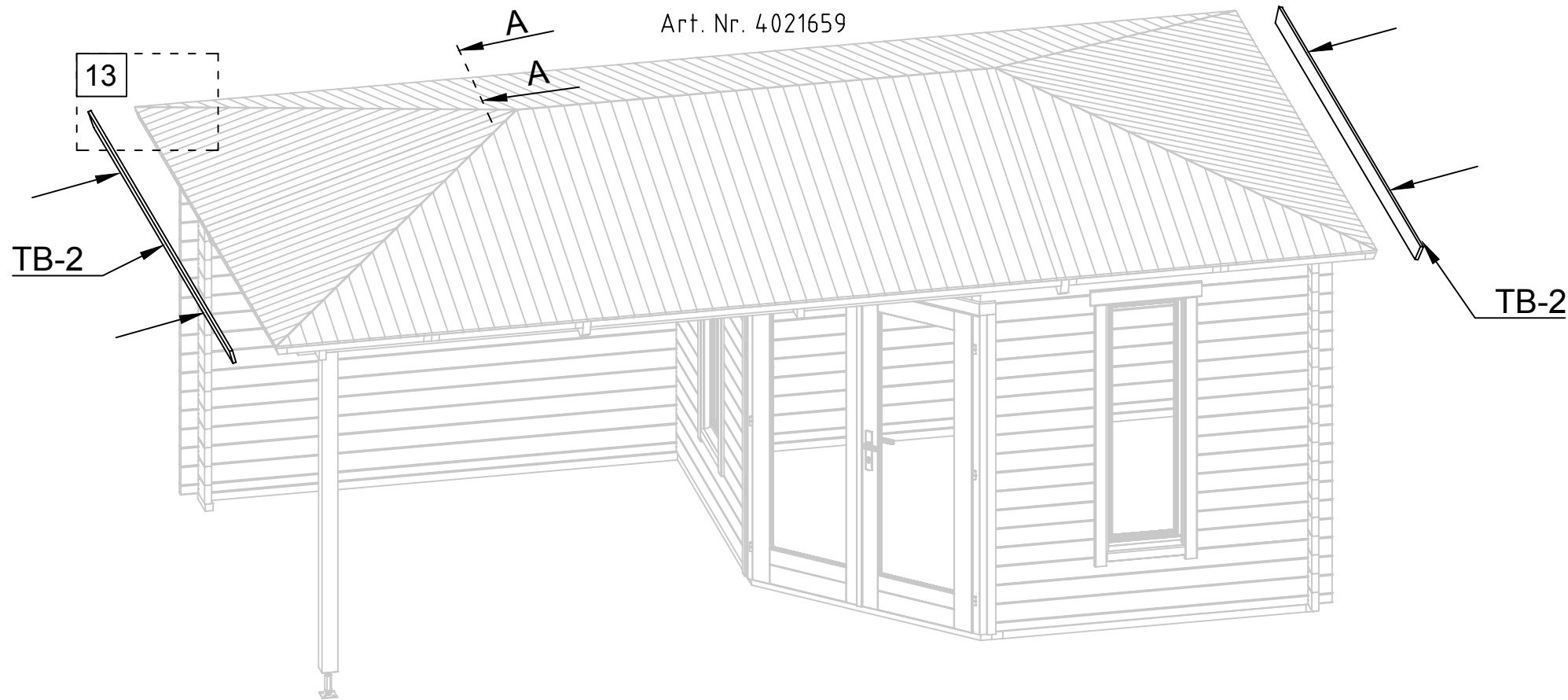

A-A

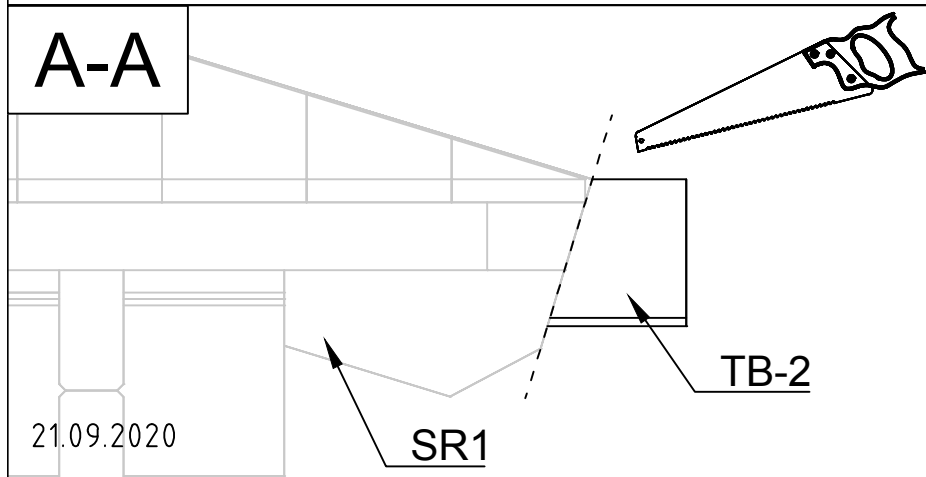



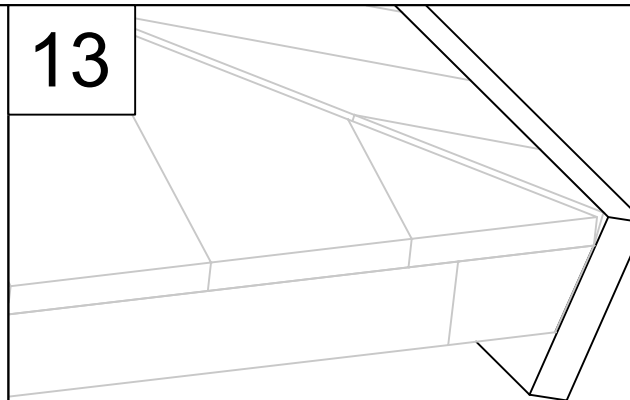





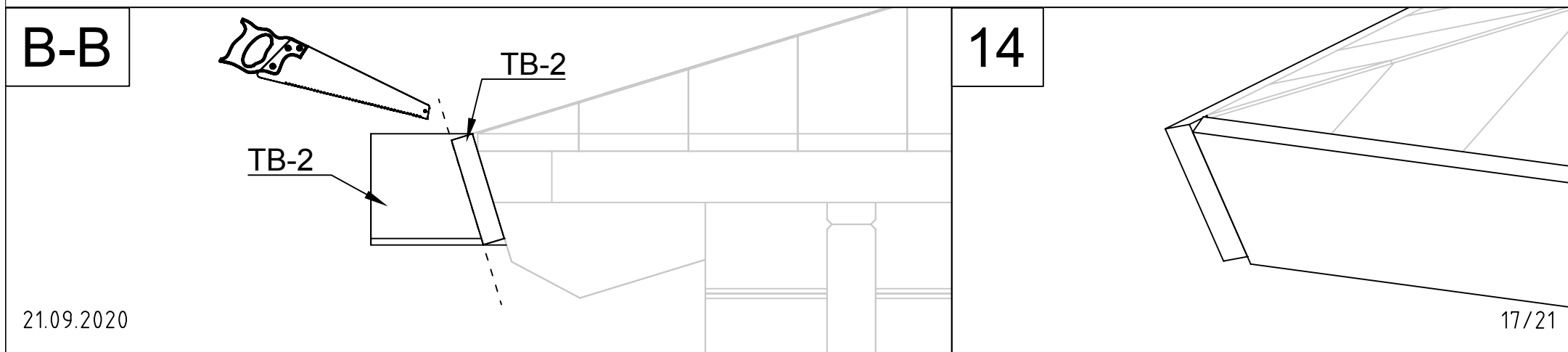
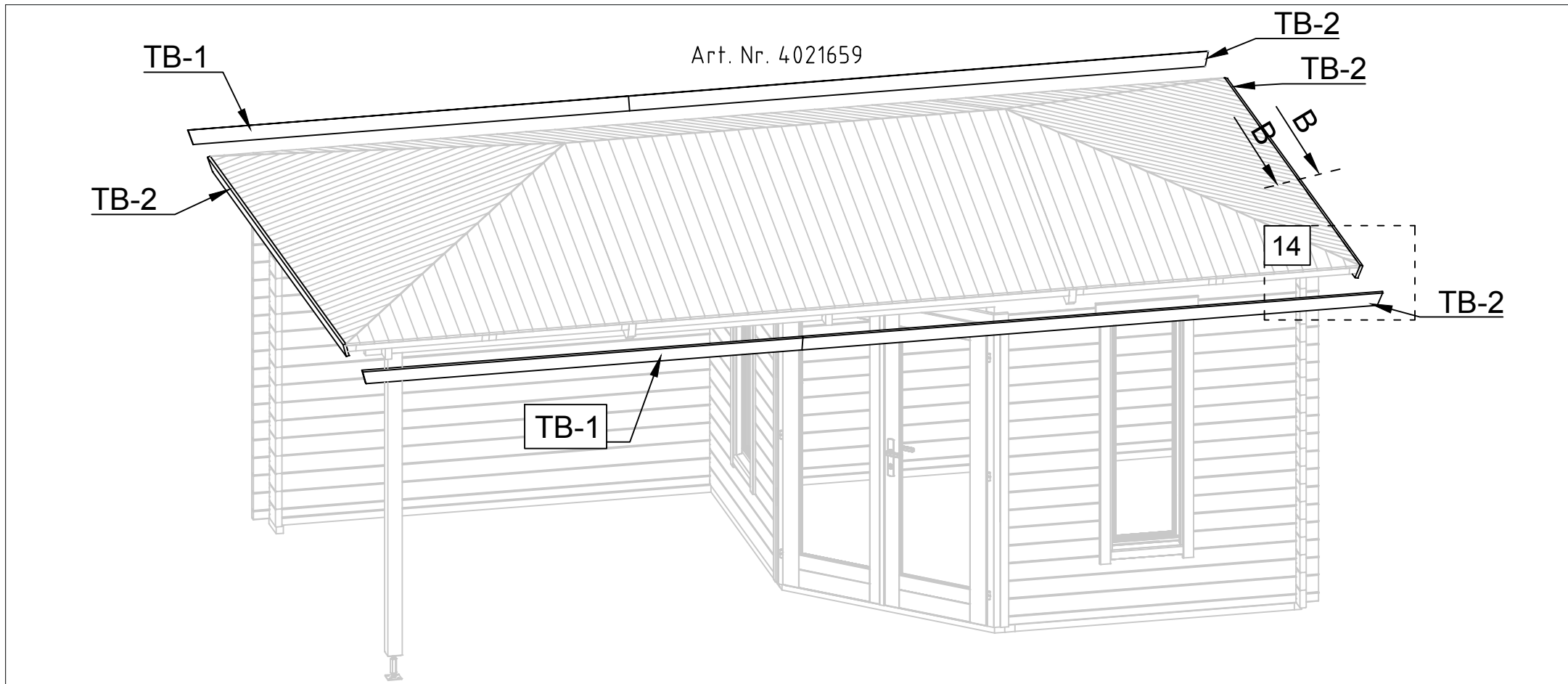

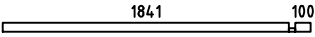
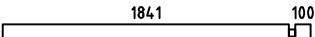
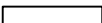
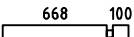
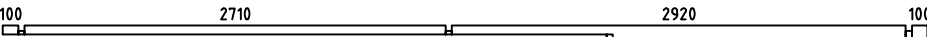
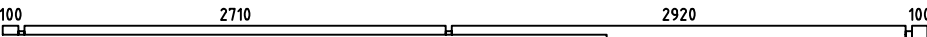
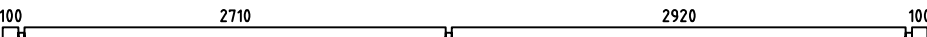
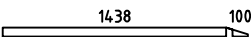
13

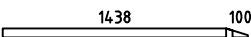

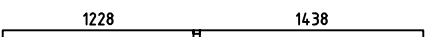
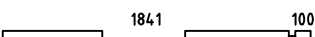
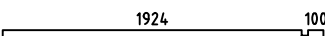
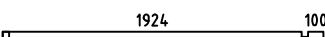
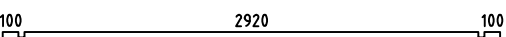

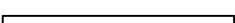

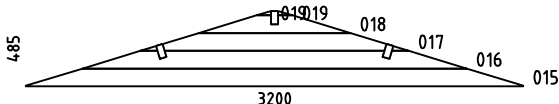

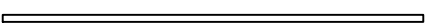

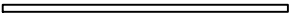

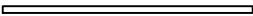





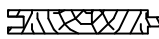
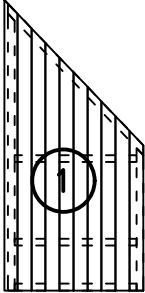

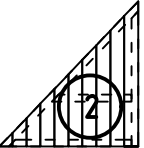
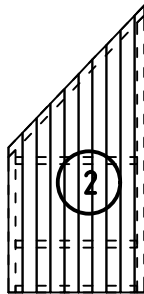
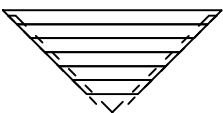

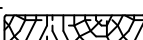

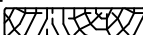

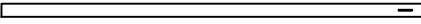
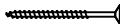
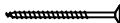
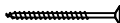
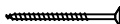
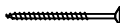
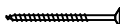



21.09.2020

16/21









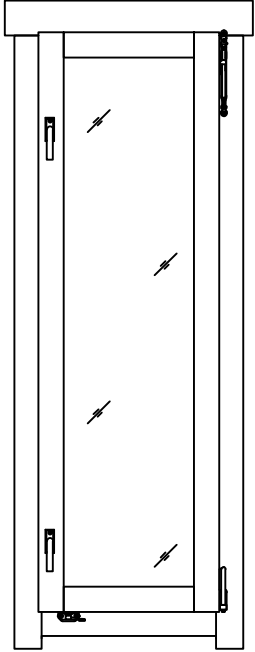
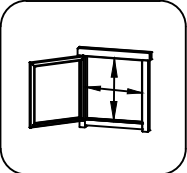
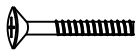

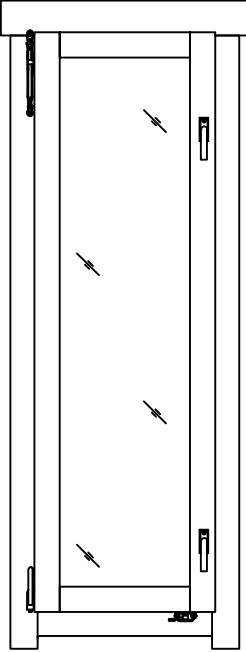
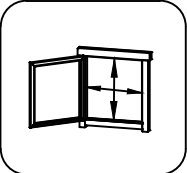

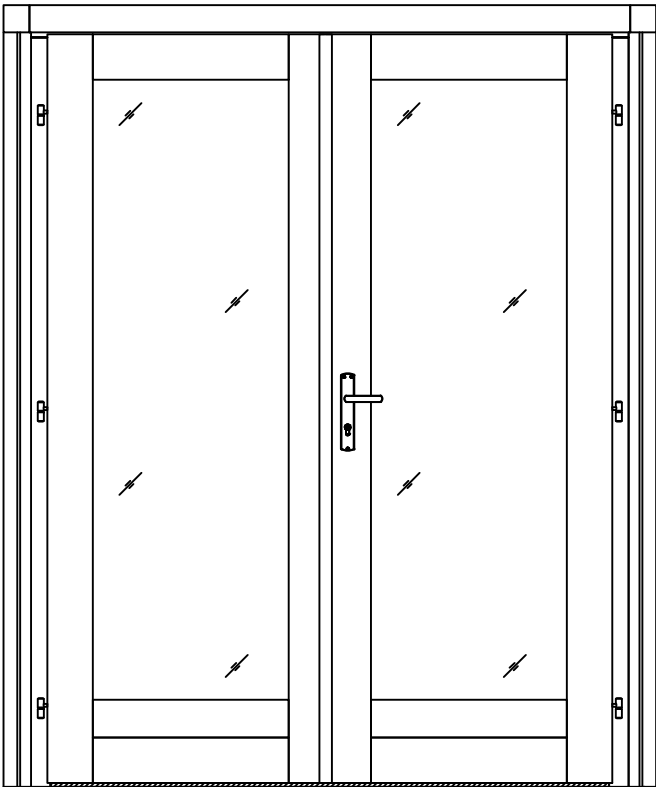
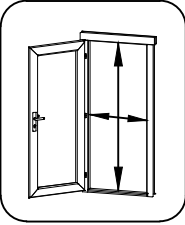

Pos	21.09.2020 Piece list - Stückliste - Liste des pièces - Elementi - Stuklijst - Tükitalabel Art. Nr. 4021659 18/21	Q	P (mm)	L (mm)
001		1	40x57	1981
002		6	40x114	1981
003		27	40x114	640
004		27	40x114	808
005a		1	40x114	5950
005b		1	40x114	5950
006		20	40x114	5950
007		2	40x57	1578
008		1	40x57	2706
009		2	40x57	1578
010		1	40x57	5950
011		1	40x57	2706
012		1	40x114	1981
013a		1	40x114	2064
013b		1	40x114	2064
014		22	40x114	3200
020		2	40x114	3200
021		1	40x114	1489
022		18	40x114	300
WA-1		1		
IAR5	Foundation - Fundament - Fondation - Fondamenta - Fundering - Immutatud alusraam 	2	45x45	2945
IAR6	Foundation - Fundament - Fondation - Fondamenta - Fundering - Immutatud alusraam 	1	45x45	2705

Pos	21.09.2020 Piece list - Stückliste - Liste des pièces - Elementi - Stuklijst - Tükitalabel Art. Nr. 4021659	19/21	Q	P (mm)	L (mm)
IAR4	Foundation - Fundament - Fondation - Fondamenta - Fundering - Immutatud alusraam 		1	45x45	1834
IAR7	Foundation - Fundament - Fondation - Fondamenta - Fundering - Immutatud alusraam 		1	45x45	1789
IAR3	Foundation - Fundament - Fondation - Fondamenta - Fundering - Immutatud alusraam 		1	45x45	1698
IAR2	Foundation - Fundament - Fondation - Fondamenta - Fundering - Immutatud alusraam 		1	45x45	1608
IAR1	Foundation - Fundament - Fondation - Fondamenta - Fundering - Immutatud alusraam 		1	45x45	190
SR1	Rafter - Dachsparren - Chevron - Trave - Dak spar - Sarikas 		6	44x140	1845
RV2	Lath - Pfetten - Liteau - Piccola asse - Gordingen - Roov 		2	44x44	1438
RV1	Lath - Pfetten - Liteau - Piccola asse - Gordingen - Roov 		2	44x44	1228
A-PR2	Roof beam - Dachbalken - Panne de toit - Perlina del tetto - Gordingen / dakbalk - Pärтин 1272 1482 		1	44x140	2794
A-PR1	Roof beam - Dachbalken - Panne de toit - Perlina del tetto - Gordingen / dakbalk - Pärтин 1228 1438 		2	44x140	2706
	Roof boards - Dachbretter - Voliges - Perlina per tetto - Dakhout - Katuselaud 		62	90x15	1868
EL	Roof shield detail - Element - Panneau de toiture - Elementi della copertura superiore del tetto - Katusekilp  		4	59x1787x1868	
EL	Roof shield detail - Element - Panneau de toiture - Elementi della copertura superiore del tetto - Katusekilp  		4	59x1787x1868	
CS	Ceiling shield - Element - Panneau de toiture - Pannello del soffitto - Plafond bedeking - Laekilp 		1	46x705x1409	
	Post - Pfosten - Poteau - Piede registrabile - Stijl - Post 		1	90x90	2000
TB-1	Fascia board - Traufbrett - Bandeau de toit - Finitura lati tetto - Gevellijst - Räästalaud 		2	18x90	2800

Pos	21.09.2020 Piece list - Stückliste - Liste des pièces - Elementi - Stuklijst - Tükitalabel Art. Nr. 4021659 20/21	Q	P (mm)	L (mm)
TB-2	Fascia board - Traufbrett - Bandeau de toit - Finitura lati tetto - Gevellijst - Räästalaud 	4	18x90	3700
DRV-1	Roof edge reinforcement - Dachrandverstärkung - Corniere de renfort de bord de toit - Rinforzo x tetto - Dakrand versterking - Räästatugevdus 	2	44x44	2706
	Beam - Balkenlage - Solive(s) - Trave - Balk (gording) - Tala 	1	44x120	1330
KFS-1	Storm protection - Sturmleiste - Latte anti-tempete - Protezione anti vento - Stormverankering / beveiliging - Tormikinnitusliist 	5	22x45	2050
HS14	Screw for post - Schrauben für pfosten - Vis de fixation des poteaux - Viti per inviare - Schroef voor stijlen - Kruvi postile 	2	4.5x80	
HS12	Screw for fascia boards - Schrauben für traufbretter - Vis pour fixation bandeau de toit - Viti x striscia del tetto - Schroef voor gevellijst - Kruvi räästalaualae 	46	4x40	
HS12	Screw for roof edge reinforcement - Schrauben für dachrandverstärkung - Vis pour fixation corniere renfort de bord de toit - Viti x rinforzo bordo tetto - Schroef voor dakrand versterking - Kruvi räästatugevdusele 	14	4x40	
HS13	Screw for triangular fixing - Montagschraube für dreieckige - Vis d'assemblage pour triangle - Vite per fissaggio triangolare - Schroef voor driehoekig afdekljst - Kruvi kolmnurga monteerimiseks seinale 	10	4x60	
HS13	Screw for wall details - Schraube für wand details - Vis pour mur details - Viti per elementi della porta - Schroef voor wand details - Kruvi seinadetailidele 	4	4x60	
HS18	Screw for fixing roof elements - Schraube für befestigung dachelementen - Vis de fixation des panneaux de toit - Vite per fissare gli elementi del tetto - Schroef voor bevestiging dakelement - Kruvi kilpide kinnitamiseks seinaga 	48	5x120	
HS18	Screw for roof beams - Schrauben für dachbalken - Vis pour fixation pannes de toit - Viti per perline del tetto - Schroef voor gordingen / dakbalken - Kruvi pärlinitele 	29	5x120	
HS18	Screw for wall details - Schraube für wand details - Vis pour mur details - Viti per elementi della porta - Schroef voor wand details - Kruvi seinadetailidele 	10	5x120	
HS18	Screw for gable - Schrauben für giebel - Vis pour fixation des pignons - Viti per timpano - Schroef voor gevelpunt - Kruvi viilude kinnitamiseks 	4	5x120	
HS16	Screw for 1. wall beam - Schraube für 1. bohlenreihe - Vis de fixations 1ere rangée de madriers avec poutrelles de fondations - Vite fissaggio alle fondamenta - Schroef voor 1 wandbalk - Kruvi poollauale 	7	5x90	
HS16	Screw for foundation - Schrauben zur befestigung fundament - Vis de fixations des poutrelles de fondations - Viti x fondamenta - Schroef voor fundering - Kruvi alusraamile 	7	5x90	
HS16	Screw for roof lath - Schraube für dachlatte - Vis pour latte - Vite per listello del tetto - Schroef voor daklat - Kruvi roovile 	8	5x90	
HS16	Screw for wall details - Schraube für wand details - Vis pour mur details - Viti per elementi della porta - Schroef voor wand details - Kruvi seinadetailidele 	14	5x90	
HS16	Screw for foundation - Schrauben zur befestigung fundament - Vis de fixations des poutrelles de fondations - Viti x fondamenta - Schroef voor fundering - Kruvi alusraamile 	2	5x90	
HS23	Screw for wall details - Schraube für wand details - Vis pour mur details - Viti per elementi della porta - Schroef voor wand details - Kruvi seinadetailidele 	5	6x180	
HS20	Screw for post height adjustment - Schrauben für regulierungsschraube für pfosten - Vis de fixation de support réglable de poteau - Viti per fissare ed aggiustare l'altezza del palo verticale - Schroef voor hoogte instelling stijlen - Kruvi vajumisplidile 	8	6x50	
HS21	Screw for fixing roof elements - Schraube für befestigung - dachelementen - Vis de fixation des panneaux de toit - Vite per fissare gli elementi del tetto - Schroef voor bevestiging dakelement - Kruvi kilpide montaažiks 	120	6x80	
HS21	Screw for beam - Schrauben zur befestigung dachsparren - Vis pour solive - Viti per perline - Schroef voor balk (gording) - Kruvi talale 	8	6x80	
SH40	Hammer block - Schlagholz - Calle de frappe - Blocco di legno da usare come cuscinetto quando si usa il martello - Slagklos - Löögiklots 	2		

Pos	21.09.2020 Piece list - Stückliste - Liste des pièces - Elementi - Stuklijst - Tükítabel 525x1560 AK.1.100.PSP.j DGP	1/1	Q	P (mm)	L (mm)
	<p data-bbox="258 152 1292 183">Glass size - Glasgröße - Taille de la vitre - Misura del vetro - Glas afmeting - Klaasi mõõt: 355x1382 mm</p>   <p data-bbox="1364 347 1500 376">425x1464 mm</p>				
FS1	<p data-bbox="258 2042 1021 2101">Window handle fittings - Fenstergriff - Poignee de fenetre - Maniglia c/ferramenta - Raamhendel -/grendel -/klink - Aknalink</p>		2		
FSP	<p data-bbox="258 2123 1101 2199">Bolt for window handle fittings - Bolzen für fenstergriff beschlag - Vis pour fixation poignee de fenetre - Bullone x apertura manuale finestra - Schroef voor raamhendel - Akna käepideme polt</p>		4		

Pos	21.09.2020 Piece list - Stückliste - Liste des pièces - Elementi - Stuklijst - Tükítabel 525x1560 AK.1.100.PSV.j DGP	1/1	Q	P (mm)	L (mm)
	<p data-bbox="258 152 1292 183">Glass size - Glasgröße - Taille de la vitre - Misura del vetro - Glas afmeting - Klaasi mõõt: 355x1382 mm</p>   <p data-bbox="1364 347 1500 376">425x1464 mm</p>				
FS1	<p data-bbox="258 2042 1021 2101">Window handle fittings - Fenstergriff - Poignee de fenetre - Maniglia c/ferramenta - Raamhendel -/grendel -/klink - Aknalink</p>			2	
FSP	<p data-bbox="258 2123 1101 2199">Bolt for window handle fittings - Bolzen für fenstergriff beschlag - Vis pour fixation poignee de fenetre - Bullone x apertura manuale finestra - Schroef voor raamhendel - Akna käepideme polt</p>			4	

Pos	21.09.2020	Piece list - Stückliste - Liste des pièces - Elementi - Stuklijst - Tükítabel 1494x1957 TUK.1.100.PVP.MM5b DGP	1/2	Q	P (mm)	L (mm)
Glass size - Glasgröße - Taille de la vitre - Misura del vetro - Glas afmeting - Klaasi mõõt: 524x1618 mm				  <p>1418x1900 mm</p>		
1	Left door jamb - Türrahmen links - Cadre de porte gauche - Telaio montante sinistro della porta - Linkerstijl deurframe - Ukse vasak leng		1	102x97	1957	
1	Right door jamb - Türrahmen rechts - Cadre de porte droit - Telaio montante destro della porta - Rechterstijl deurframe - Ukse parem leng		1	102x97	1957	
2	Upper door jamb - Türrahmen oben - Cadre de porte supérieur - Telaio superiore della porta - Bovendorpel - Ukse ülemine leng		1	77x38	1538	
3	Covering moulding - Deckungsprofil - Profils de finition verticaux a fixer a l'exterieur du cadre de la porte - Cornice di finitura - Afdek profiel - Lengi piirdelaud		4	28x50	1942	
4	Covering moulding - Deckungsprofil - Profils de finition verticaux a fixer a l'exterieur du cadre de la porte - Cornice di finitura - Afdek profiel - Lengi piirdelaud		2	28x70	94	
5	Covering moulding - Deckungsprofil - Profils de finition verticaux a fixer a l'exterieur du cadre de la porte - Cornice di finitura - Afdek profiel - Lengi piirdelaud		2	28x70	66	
6	Covering moulding - Deckungsprofil - Profils de finition verticaux a fixer a l'exterieur du cadre de la porte - Cornice di finitura - Afdek profiel - Lengi piirdelaud		1	28x70	1489	
7	Covering moulding - Deckungsprofil - Profils de finition verticaux a fixer a l'exterieur du cadre de la porte - Cornice di finitura - Afdek profiel - Lengi piirdelaud		1	28x70	1546	
8	Connection strip - Deckleiste - Baguette de battement - Profilo verticale della porta - Stulplijst - Kokkuvaltssiliist		1	13x32	1927	
9	Doorstep - Swelle - Barre de seuil - Soglia della porta - Deurdorpel - Lävepakk		1	18x77	1438	

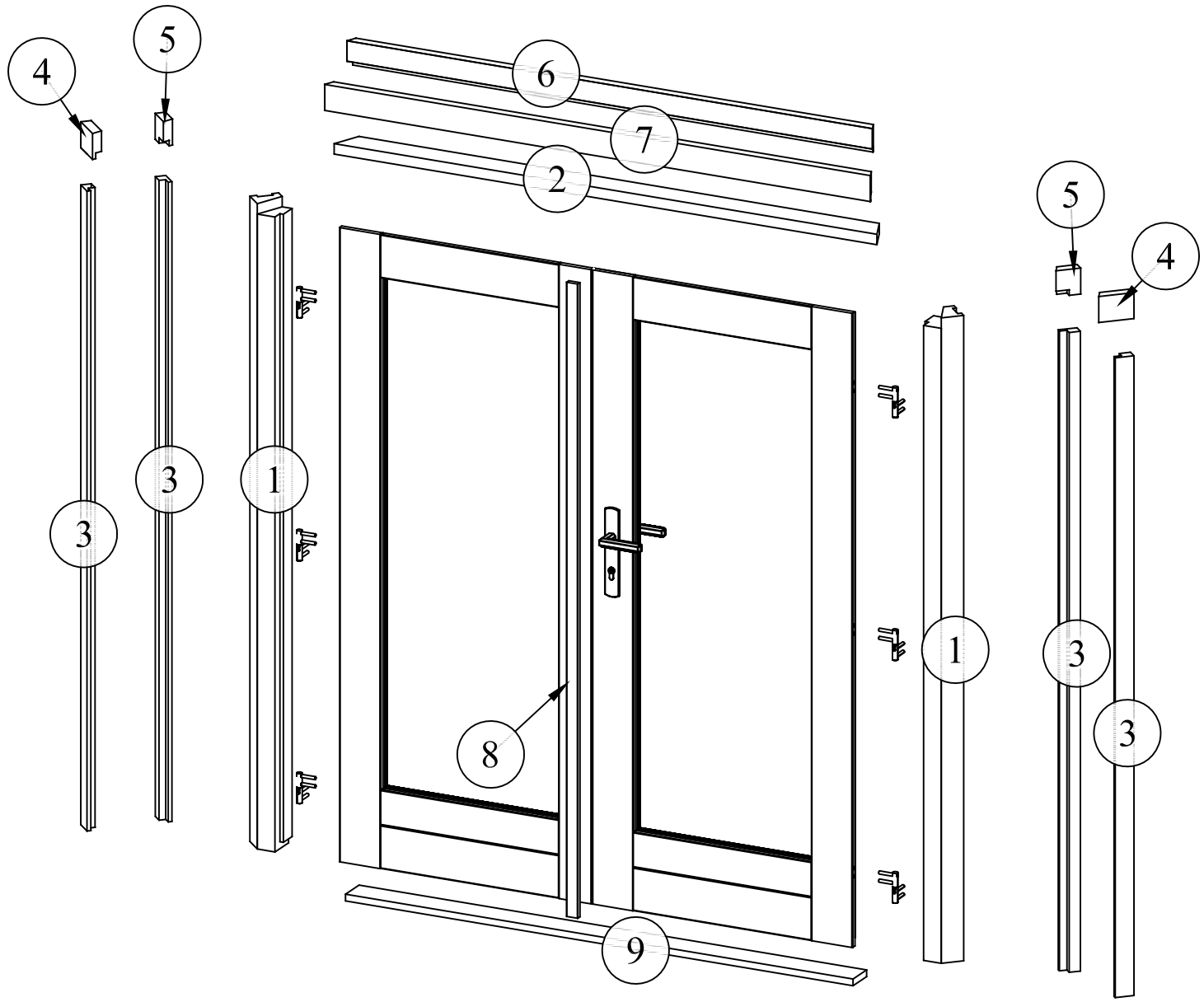

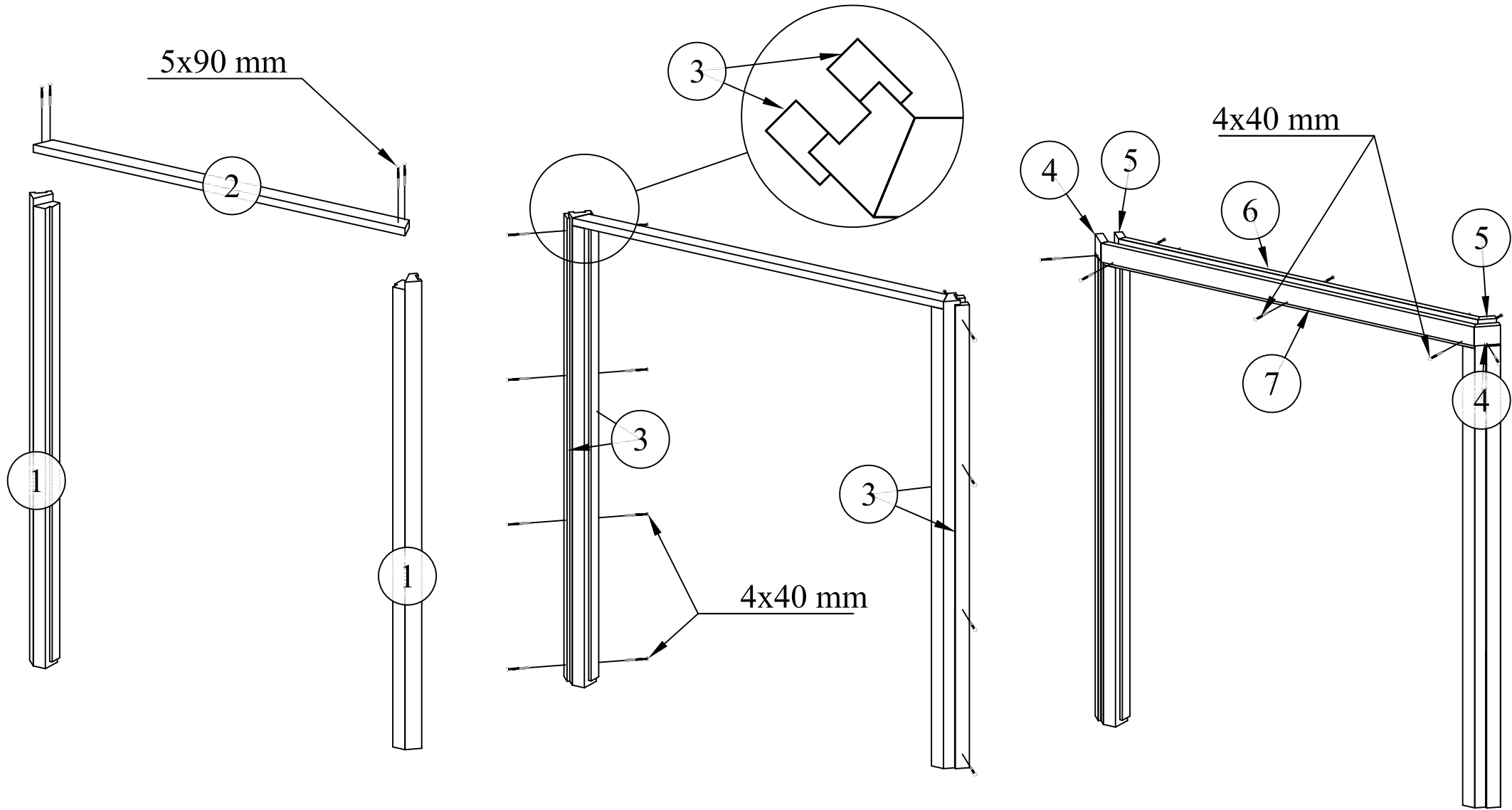

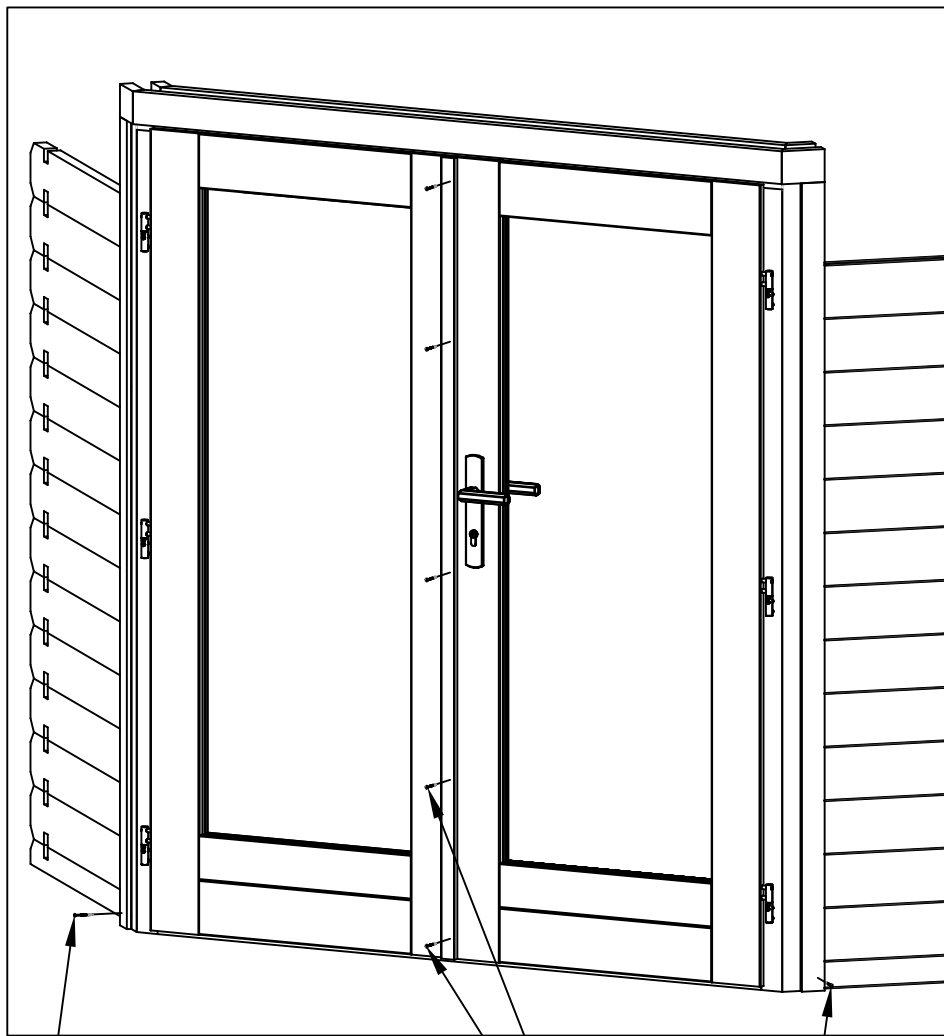

3.5x50 mm

3x30 mm

3.5x50 mm

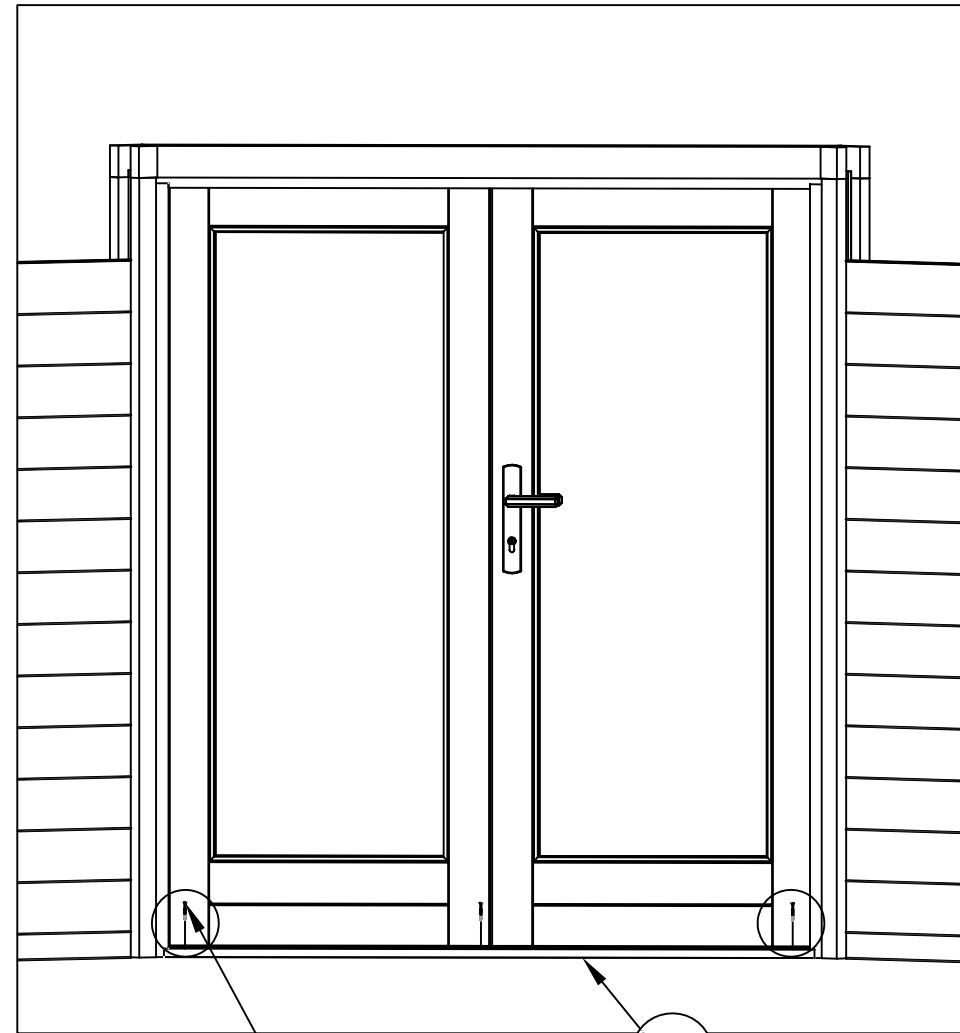

4.5x65 mm

9